

Write your name here

Surname

Other names

**Pearson Edexcel  
International GCSE**

Centre Number

--	--	--	--	--	--

Candidate Number

--	--	--	--	--

# Biology

**Unit: 4BI0**

**Science (Double Award) 4SC0**

**Paper: 1B**

Tuesday 9 January 2018 – Afternoon

**Time: 2 hours**

Paper Reference

**4BI0/1B  
4SC0/1B**

**You must have:**

Ruler

Calculator

Total Marks

## Instructions

- Use **black** ink or ball-point pen.
- **Fill in the boxes** at the top of this page with your name, centre number and candidate number.
- Answer **all** questions.
- Answer the questions in the spaces provided  
– *there may be more space than you need.*
- Show all the steps in any calculations and state the units.

## Information

- The total mark for this paper is 120.
- The marks for **each** question are shown in brackets  
– *use this as a guide as to how much time to spend on each question.*

## Advice

- Read each question carefully before you start to answer it.
- Write your answers neatly and in good English.
- Try to answer every question.
- Check your answers if you have time at the end.

Turn over ►

P51854A

©2018 Pearson Education Ltd.

1/1/1/1/1/1/



Pearson

**Answer ALL questions.**

**1** The diagram shows a food web on a farm.

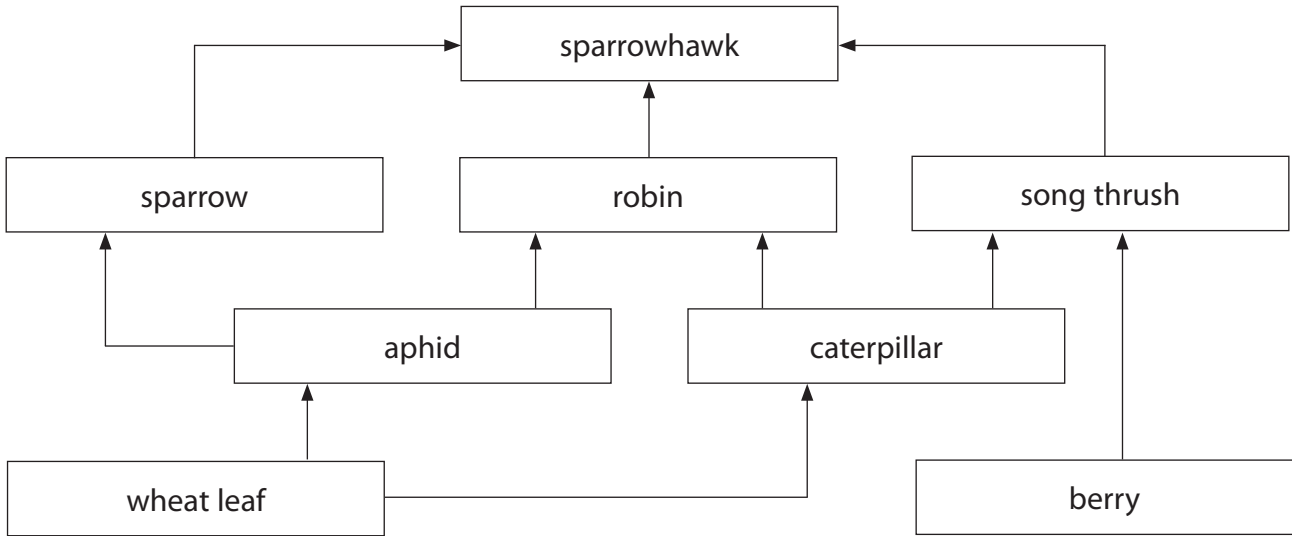

(a) (i) How many trophic levels are shown in this food web?

(1)

(ii) Which organism in this food web is a primary consumer and also a secondary consumer?

(1)

(iii) Suggest why the farmer uses a pesticide to control the aphids.

(2)

DO NOT WRITE IN THIS AREA

DO NOT WRITE IN THIS AREA

DO NOT WRITE IN THIS AREA



(iv) Explain how this pesticide would affect the population of sparrowhawks.

(2)

.....

.....

.....

.....

.....

.....

(b) Farmers sometimes use biological control rather than pesticides.

State three advantages of using biological control rather than pesticides.

(3)

1.....

.....

2.....

.....

3.....

.....

**(Total for Question 1 = 9 marks)**

DO NOT WRITE IN THIS AREA

DO NOT WRITE IN THIS AREA

DO NOT WRITE IN THIS AREA



2 A meal contains different food components.

(a) The table lists some of the components in the meal.

Complete the table by giving the function of each component.

One has been done for you.

(4)

Component	Function of component
vitamin A	
vitamin C	
vitamin D	bone growth
iron	
dietary fibre	

(b) Describe a test to show that the meal contains glucose.

(3)

.....

.....

.....

.....

.....

.....

.....

.....

.....

.....

DO NOT WRITE IN THIS AREA

DO NOT WRITE IN THIS AREA

DO NOT WRITE IN THIS AREA



(c) The meal also contains lipids and proteins.

- (i) Give the three chemical elements found in lipids and also found in proteins. (1)

(ii) The table lists two substances involved in the digestion of lipids.

Complete the table by naming an organ that produces each substance. (2)

Substance	Organ
bile	
lipase	

(Total for Question 2 = 10 marks)

DO NOT WRITE IN THIS AREA

DO NOT WRITE IN THIS AREA

DO NOT WRITE IN THIS AREA



3 A student investigates the effect of carbon dioxide on photosynthesis.

The student places a plant in the dark to remove starch from its leaves.

(a) Explain why a leaf becomes destarched if it is placed in the dark.

(2)

.....

.....

.....

.....

(b) The student puts one of the destarched leaves through the bung of a glass jar containing potassium hydroxide, as shown in the diagram.

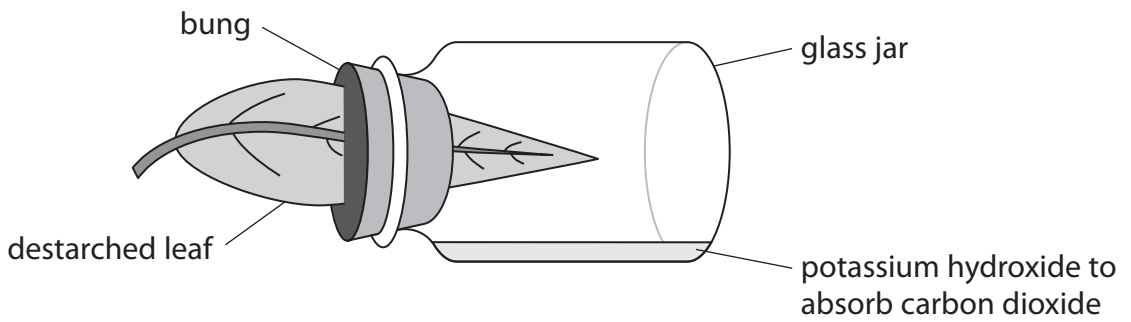

She places the apparatus in the light for 24 hours, and then tests the leaf for starch.

(i) Describe a safe method of testing this leaf for starch.

(4)

.....

.....

.....

.....

.....

.....

.....

.....

.....

.....

.....



(ii) Draw a labelled diagram of the leaf to show the results of the starch test.

(2)

DO NOT WRITE IN THIS AREA

DO NOT WRITE IN THIS AREA

DO NOT WRITE IN THIS AREA

**(Total for Question 3 = 8 marks)**



- 4 (a) When a person touches the spine of a cactus plant, they quickly withdraw their hand.  
The diagram shows the reflex arc involved in this response.

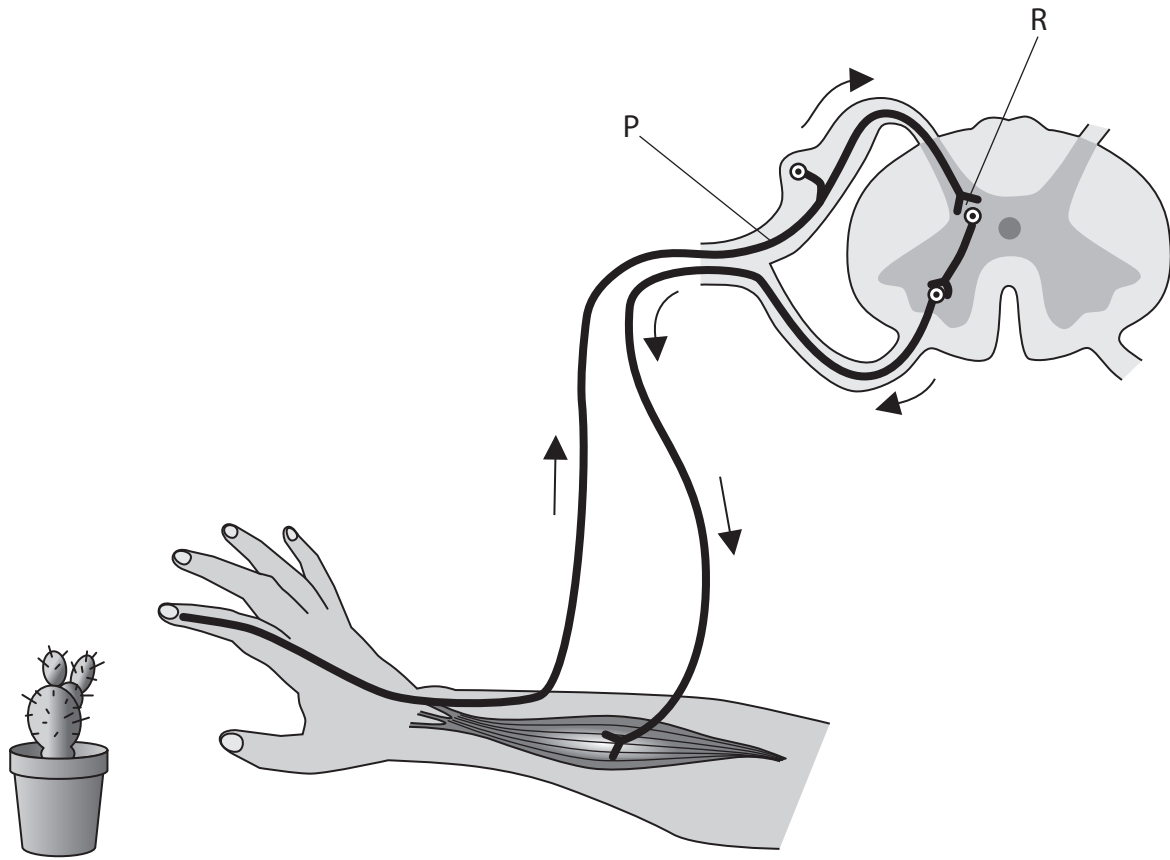

(i) Give the name of neurone P.

(1)

(ii) Describe what happens at R.

(2)

DO NOT WRITE IN THIS AREA

DO NOT WRITE IN THIS AREA

DO NOT WRITE IN THIS AREA





(iii) Draw a labelled diagram of the motor neurone involved in this response.

(3)

(iv) Explain the role of the motor neurone in this response.

(2)

.....

.....

.....

.....

DO NOT WRITE IN THIS AREA

DO NOT WRITE IN THIS AREA

DO NOT WRITE IN THIS AREA



(b) Krabbe disease is an inherited disease that affects the structure and function of motor neurones. The disease is caused by a recessive allele.

Two parents are heterozygous for Krabbe disease.

- (i) Draw a genetic diagram to show the genotypes of these parents, their gametes and their possible offspring.

Use D for the dominant allele and d for the recessive allele.

(3)

- (ii) Calculate the probability of these parents producing a male child with Krabbe disease. (1)

probability = .....

- (iii) In the UK, the probability of being born with Krabbe disease is 0.00001

There are about 733 000 births per year in the UK.

Calculate the number of children born per year in the UK who are likely to have Krabbe disease.

Show your working.

(2)

number = .....

**(Total for Question 4 = 14 marks)**



5 The diagram shows a yeast cell.

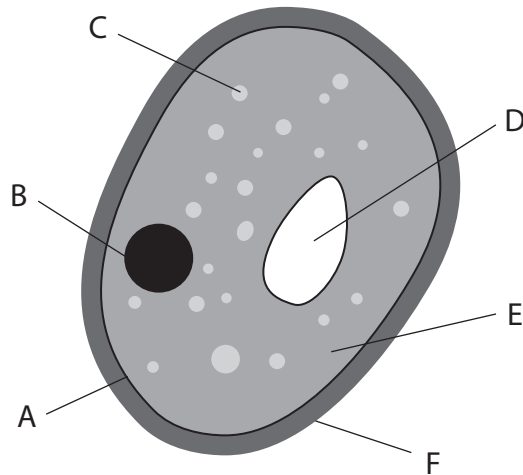

(a) (i) Give the letter of the part made of chitin.

(1)

(ii) Give the letter of the part made of glycogen.

(1)

(b) Anaerobic respiration in yeast cells produces a gas.

Write the word equation for anaerobic respiration in yeast cells.

(2)



- (c) A student uses this apparatus to investigate the effect of temperature on anaerobic respiration in yeast.

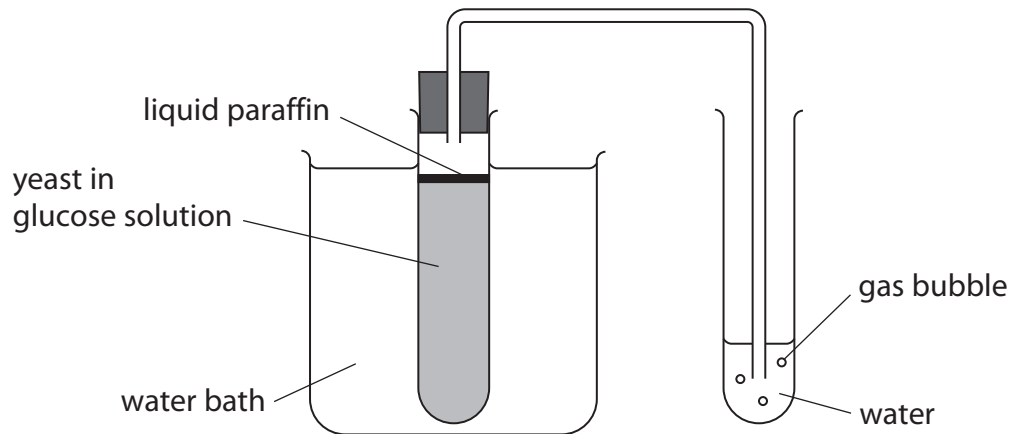

The student uses the water bath to control the temperature of the yeast in glucose solution.

He measures the rate of anaerobic respiration by counting the number of gas bubbles produced in one minute.

The table shows the student's results.

Temperature of water bath in °C	Rate of anaerobic respiration in bubbles per minute
20	3
25	5
30	7
36	10
40	14
45	20
52	3



- (i) Plot a graph to show the effect of temperature on the rate of anaerobic respiration.  
Use a ruler to join the points with straight lines.

(5)

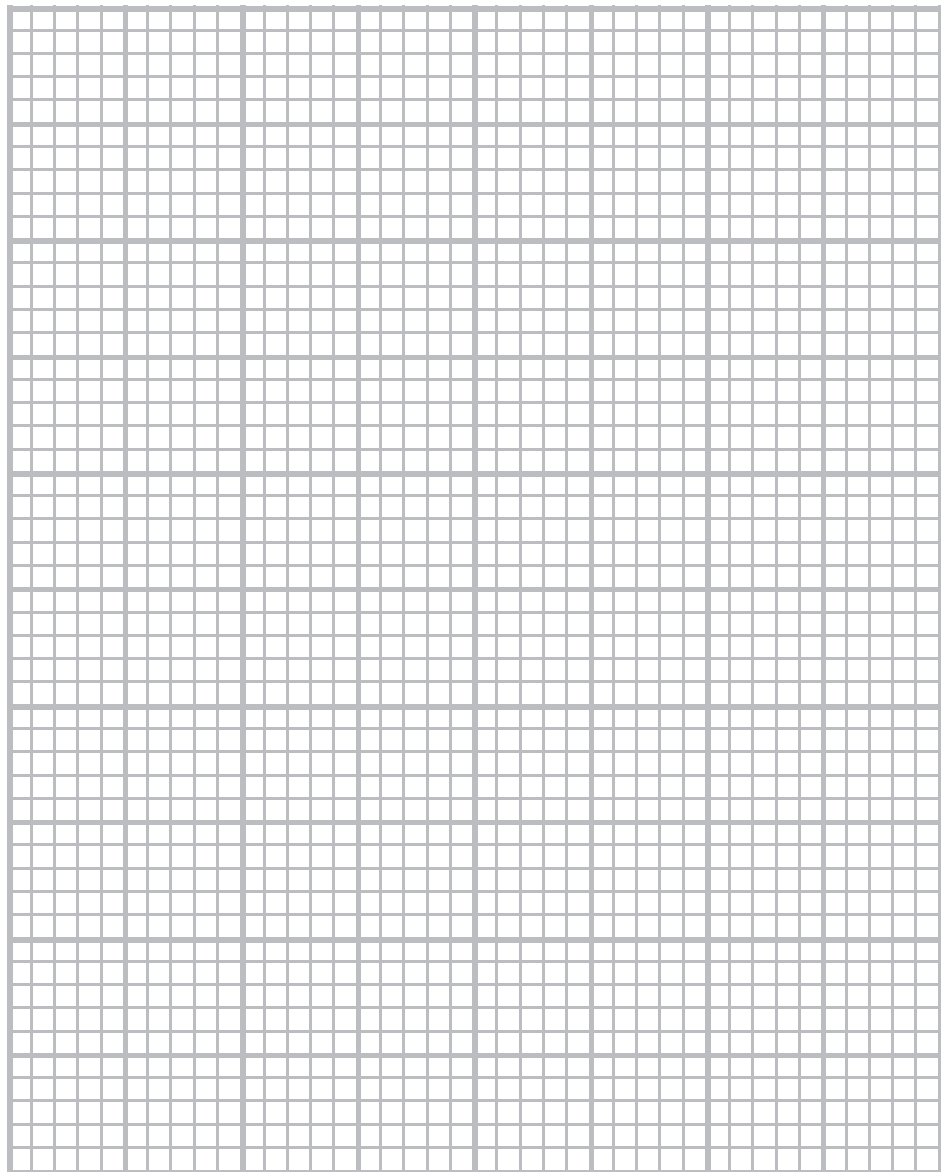

- (ii) Explain the role of the liquid paraffin in this investigation.

(2)

.....

.....

.....

.....

DO NOT WRITE IN THIS AREA

DO NOT WRITE IN THIS AREA

DO NOT WRITE IN THIS AREA



(iii) Explain how the student could modify his method to improve his results.

(2)

.....

.....

.....

.....

.....

.....

(iv) Explain the results obtained at 20 °C and at 52 °C.

(4)

20 °C.....

.....

.....

.....

.....

.....

.....

52 °C.....

.....

.....

.....

.....

.....

.....

**(Total for Question 5 = 17 marks)**



DO NOT WRITE IN THIS AREA

DO NOT WRITE IN THIS AREA

DO NOT WRITE IN THIS AREA

DO NOT WRITE IN THIS AREA

DO NOT WRITE IN THIS AREA

DO NOT WRITE IN THIS AREA

6 If a person drinks a lot of water, the water content of their blood will increase.

(a) Describe how the water content of their blood is regulated.

(5)

Dotted lines for writing answer (a).

(b) Explain why red blood cells would be damaged if the water content of the blood increased.

(3)

Dotted lines for writing answer (b).

(Total for Question 6 = 8 marks)



7 Explants are produced during the process of micropropagation.

These explants are sterilised with a dilute solution of bleach.

The solution of bleach kills surface microorganisms.

Design an investigation to find the best concentration of bleach to use.

Your answer should include experimental details and be written in full sentences.

(6)

Area with horizontal dotted lines for writing the answer.

(Total for Question 7 = 6 marks)

DO NOT WRITE IN THIS AREA

DO NOT WRITE IN THIS AREA

DO NOT WRITE IN THIS AREA





DO NOT WRITE IN THIS AREA

DO NOT WRITE IN THIS AREA

DO NOT WRITE IN THIS AREA

8 (a) The diagram shows part of the human thorax.

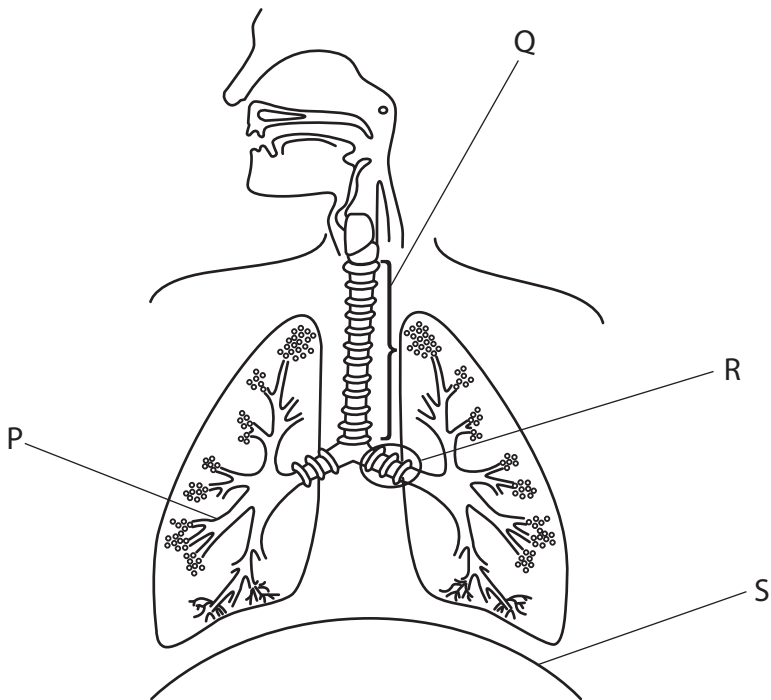

(i) Give the names of structures P, Q and R.

(3)

P .....

Q .....

R .....

(ii) Explain the role of structure S when a person breathes out.

(3)

.....

.....

.....

.....

.....

.....

.....

.....

.....

.....



(b) Asthma is a disease that narrows the airways in the lungs.

A peak flow test is used to diagnose and monitor asthma.

The test measures how fast you can blow air out of your lungs.

The test involves blowing as hard as you can into a small device called a peak flow meter.

Blowing into the peak flow meter moves a slider along the measurement scale.

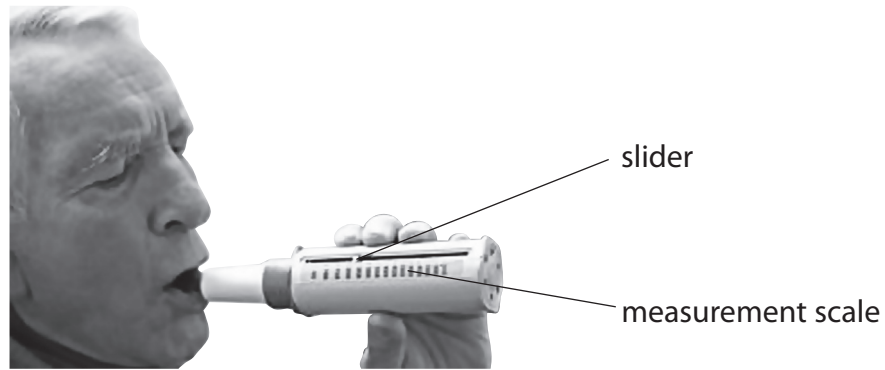

© 1999-2016 Masterfile Corporation

These instructions are provided to help measure peak flow.

- Step 1 Sit or stand still
- Step 2 Set the meter to zero, make sure your fingers are not touching the slider and that the meter is horizontal
- Step 3 Breathe in as deeply as you can, then breathe out as quickly and as hard as you can into the peak flow meter
- Step 4 Record the measurement when you have finished breathing out
- Step 5 Repeat the procedure three times

(i) Suggest the unit that is used to measure peak flow. (1)

(ii) Explain why the instructions in step 2 are necessary. (2)



(iii) Explain why the instructions in step 5 are necessary.

(2)

.....

.....

.....

.....

(c) Bronchodilators are drugs that reduce the symptoms of asthma.

Suggest how bronchodilators might improve the peak flow of a person with asthma.

(2)

.....

.....

.....

.....

**(Total for Question 8 = 13 marks)**

DO NOT WRITE IN THIS AREA

DO NOT WRITE IN THIS AREA

DO NOT WRITE IN THIS AREA



P 5 1 8 5 4 A 0 1 9 2 4

9 (a) The table lists some types of cell found in the human body.

Complete the table by giving the number of chromosomes in each type of cell. (3)

Type of cell	Number of chromosomes
egg cell	
red blood cell	
white blood cell	

(b) Some cells divide by mitosis and other cells divide by meiosis.

(i) Mitosis is used in the process of growth.

Give two other processes that use mitosis. (2)

1 .....

2 .....

(ii) Describe how the chromosomes of a human cell produced by meiosis differ from the chromosomes of a human cell produced by mitosis. (2)

.....  
 .....  
 .....  
 .....  
 .....

(iii) Name the male part of a flowering plant where cells divide by meiosis. (1)

.....

**(Total for Question 9 = 8 marks)**

DO NOT WRITE IN THIS AREA

DO NOT WRITE IN THIS AREA

DO NOT WRITE IN THIS AREA



DO NOT WRITE IN THIS AREA

DO NOT WRITE IN THIS AREA

DO NOT WRITE IN THIS AREA

10 The passage describes hormones and coordination.

Complete the passage by writing a suitable word in each blank space.

(9)

Hormones are chemicals that are produced by endocrine .....

and are secreted into the ..... . The hormones are then

transported to target cells in another part of the body.

Males have testes that produce the sex hormone ..... that causes

body hair to grow. Females have ..... that produce the

sex hormones ..... and progesterone.

The pancreas produces hormones that regulate blood glucose. One of these hormones,

called ..... , stimulates the conversion of blood glucose

to ..... in the .....

Another hormone causes the heart rate to increase in response to danger.

This hormone is called .....

**(Total for Question 10 = 9 marks)**



11 A student investigates the populations of two plant species in two fields, A and B.

The student uses a 0.5 m × 0.5 m quadrat to count the number of plants of each species in each field. He takes five quadrat samples for each field.

The tables show the student’s results.

**Field A**

Plant species	Number of plants					Average	Average number per m <sup>2</sup>
	quadrat 1	quadrat 2	quadrat 3	quadrat 4	quadrat 5		
plantain	0	2	0	2	0	0.8	3.2
clover	1	3	2	3	1	2.0	8.0

**Field B**

Plant species	Number of plants					Average	Average number per m <sup>2</sup>
	quadrat 1	quadrat 2	quadrat 3	quadrat 4	quadrat 5		
plantain	5	2	3	7	2		
clover	5	3	6	3	0	3.4	13.6

(a) (i) Calculate the average (mean) number of plantain per m<sup>2</sup> in field B.

Show your working.

(2)

average number of plantain per m<sup>2</sup> = .....

(ii) Explain how the student should decide where to place the quadrats in each field.

(2)

.....

.....

.....

.....



(iii) Describe the differences in the plant populations shown by the student's results. (3)

Dotted lines for writing the answer to question (iii).

(b) Abiotic (non-living) factors could be the reason for the differences in the plant populations in the two fields.

Explain how two abiotic factors could cause differences in plant populations. (4)

1. Dotted lines for writing the first part of the answer to question (b).

2. Dotted lines for writing the second part of the answer to question (b).

(Total for Question 11 = 11 marks)

TURN OVER FOR QUESTION 12

DO NOT WRITE IN THIS AREA

DO NOT WRITE IN THIS AREA

DO NOT WRITE IN THIS AREA



12 Substances move in and out of cells using different processes.

(a) Complete the table by giving the process used for each example of substance movement. (3)

Example of substance movement	Process
carbon dioxide moving through stomata into a leaf	
nitrate ions moving into a plant root hair cell against a concentration gradient	
water moving from a collecting duct of the kidney into blood plasma	

(b) Explain how the structure of the small intestine is adapted for efficient absorption of substances. (4)

.....

.....

.....

.....

.....

.....

.....

.....

.....

.....

.....

.....

.....

.....

.....

.....

.....

.....

.....

.....

.....

(Total for Question 12 = 7 marks)

**TOTAL FOR PAPER = 120 MARKS**

Every effort has been made to contact copyright holders to obtain their permission for the use of copyright material. Pearson Education Ltd. will, if notified, be happy to rectify any errors or omissions and include any such rectifications in future editions.

