

Cambridge IGCSE™

CHEMISTRY

Paper 2 Multiple Choice (Extended)

0620/21

May/June 2021

45 minutes

You must answer on the multiple choice answer sheet.

You will need: Multiple choice answer sheet
Soft clean eraser
Soft pencil (type B or HB is recommended)

INSTRUCTIONS

- There are **forty** questions on this paper. Answer **all** questions.
- For each question there are four possible answers **A, B, C** and **D**. Choose the **one** you consider correct and record your choice in soft pencil on the multiple choice answer sheet.
- Follow the instructions on the multiple choice answer sheet.
- Write in soft pencil.
- Write your name, centre number and candidate number on the multiple choice answer sheet in the spaces provided unless this has been done for you.
- Do **not** use correction fluid.
- Do **not** write on any bar codes.
- You may use a calculator.

INFORMATION

- The total mark for this paper is 40.
- Each correct answer will score one mark.
- Any rough working should be done on this question paper.
- The Periodic Table is printed in the question paper.

This document has **16** pages. Any blank pages are indicated.



- 1 A gas is released at point P in the apparatus shown.

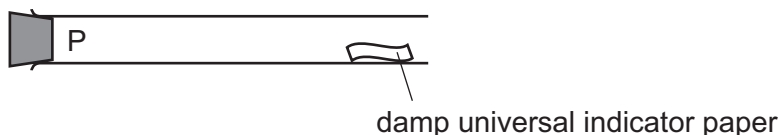

Which gas turns the damp universal indicator paper red most quickly?

- A ammonia, NH_3
 - B chlorine, Cl_2
 - C hydrogen chloride, HCl
 - D sulfur dioxide, SO_2
- 2 A mixture is separated using the apparatus shown.

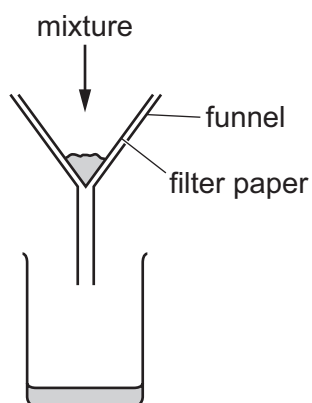

What is the mixture?

- A aqueous copper(II) sulfate and aqueous sodium chloride
 - B aqueous copper(II) sulfate and copper
 - C copper and sulfur
 - D ethanol and ethanoic acid
- 3 Which statement about paper chromatography is correct?
- A A solvent is needed to dissolve the paper.
 - B Paper chromatography separates mixtures of solvents.
 - C The solvent should cover the baseline.
 - D The baseline should be drawn in pencil.

4 Element X has 7 protons.

Element Y has 8 more protons than X.

Which statement about element Y is correct?

- A Y has more electron shells than X.
- B Y has more electrons in its outer shell than X.
- C Y is in a different group of the Periodic Table from X.
- D Y is in the same period of the Periodic Table as X.

5 A covalent molecule Q contains only six shared electrons.

What is Q?

- A ammonia, NH_3
- B chlorine, Cl_2
- C methane, CH_4
- D water, H_2O

6 The arrangement of particles in each of two solids, S and T, are shown.

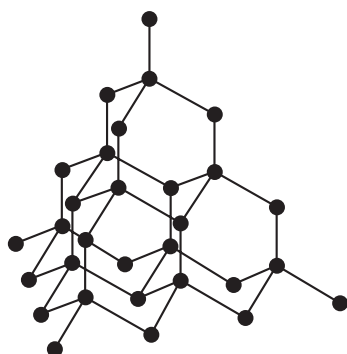

S

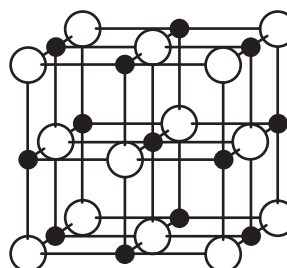

T

What are S and T?

	S	T
A	diamond	silicon(IV) oxide
B	diamond	sodium chloride
C	graphite	silicon(IV) oxide
D	graphite	sodium chloride

7 Which statement about metals is correct?

- A Metals conduct electricity when molten because negative ions are free to move.
- B Metals conduct electricity when solid because positive ions are free to move.
- C Metals are malleable because the bonds between the atoms are weak.
- D Metals are malleable because the layers of ions can slide over each other.

8 Two elements, P and Q, are in the same period of the Periodic Table.

P and Q react together to form an ionic compound. Part of the lattice of this compound is shown.

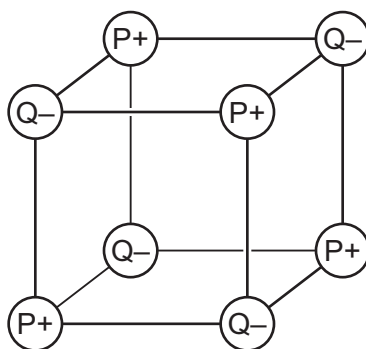

Which statement is correct?

- A An ion of P has more electrons than an ion of Q.
- B Element P is non-metallic.
- C P is to the left of Q in the Periodic Table.
- D The formula of the compound is P_4Q_4 .

9 2.56 g of a metal oxide, MO_2 , is reduced to 1.92 g of the metal, M.

What is the relative atomic mass of M?

- A 48
- B 96
- C 128
- D 192

10 In separate experiments, electricity was passed through concentrated aqueous sodium chloride and molten lead(II) bromide.

What would happen in **both** experiments?

- A A halogen would be formed at the anode.
- B A metal would be formed at the cathode.
- C Hydrogen would be formed at the anode.
- D Hydrogen would be formed at the cathode.

11 What is the ionic half-equation for the reaction that occurs at the cathode when molten lead(II) bromide is electrolysed?

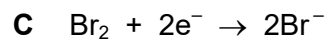
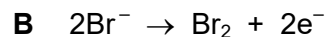
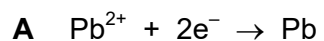

12 The complete combustion of propane is exothermic.

The equation for this reaction is shown.

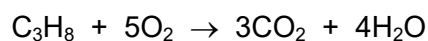

Which energy level diagram represents the complete combustion of propane?

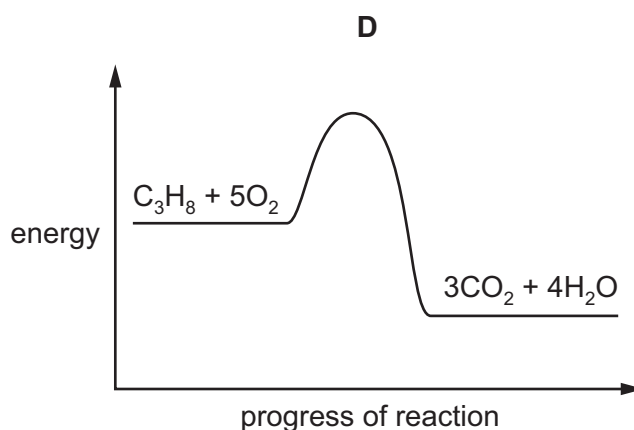
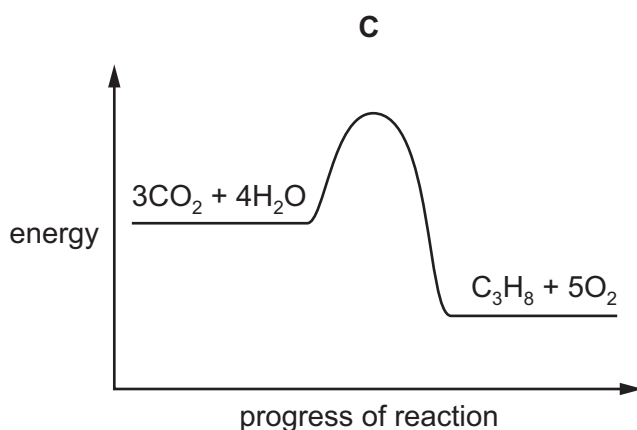
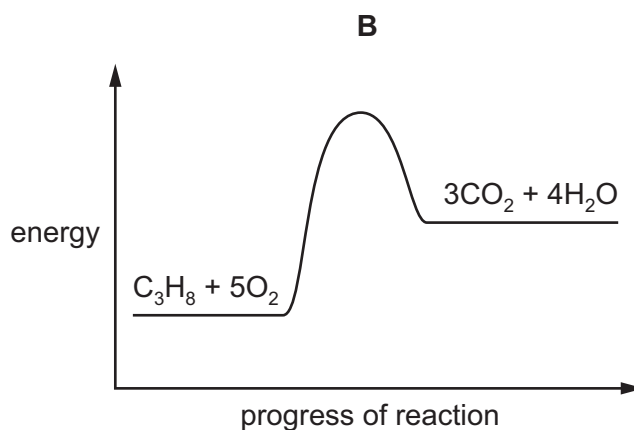
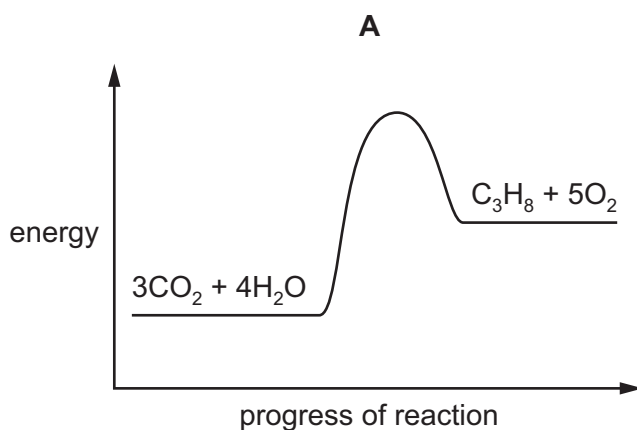

13 Which equation represents a reaction that takes place in a fuel cell?

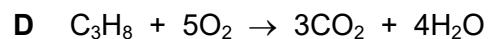
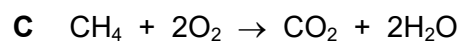
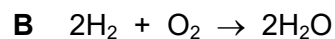
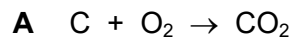

14 When sulfur is heated it undergoes a1..... change as it melts.

Further heating causes the sulfur to undergo a2..... change and form sulfur dioxide.

Which words complete gaps 1 and 2?

	1	2
A	chemical	chemical
B	chemical	physical
C	physical	chemical
D	physical	physical

15 Four statements about the effect of increasing temperature on a reaction are shown.

- 1 The activation energy becomes lower.
- 2 The particles move faster.
- 3 There are more collisions between reacting particles per second.
- 4 There are more collisions which have energy greater than the activation energy.

Which statements are correct?

- A 1, 2 and 3 B 1, 3 and 4 C 2, 3 and 4 D 2 and 3 only

16 An example of a redox reaction is shown.

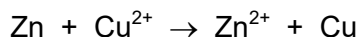

Which statement about the reaction is correct?

- A Zn is the oxidising agent and it oxidises Cu^{2+} .
 - B Zn is the oxidising agent and it reduces Cu^{2+} .
 - C Zn is the reducing agent and it oxidises Cu^{2+} .
 - D Zn is the reducing agent and it reduces Cu^{2+} .
- 17 Which statement about a reaction in equilibrium is correct?
- A Both the forward and the backward reactions are proceeding at the same rate.
 - B Neither the forward nor the backward reaction is proceeding.
 - C The amount of product present is no longer affected by changes in temperature or pressure.
 - D The amount of product present is only affected by a change in pressure.

18 Element X forms an oxide, XO, that neutralises sulfuric acid.

Which row describes X and XO?

	element X	nature of oxide, XO
A	metal	acidic
B	metal	basic
C	non-metal	acidic
D	non-metal	basic

19 Copper(II) sulfate is prepared by adding excess copper(II) oxide to warm dilute sulfuric acid.

Which purification methods are used to obtain pure solid copper(II) sulfate from the reaction mixture?

- 1 crystallisation
- 2 filtration
- 3 chromatography
- 4 distillation

- A 1 and 4
- B 1 and 2
- C 2 and 3
- D 3 and 4

20 Some reactions of element M are shown.

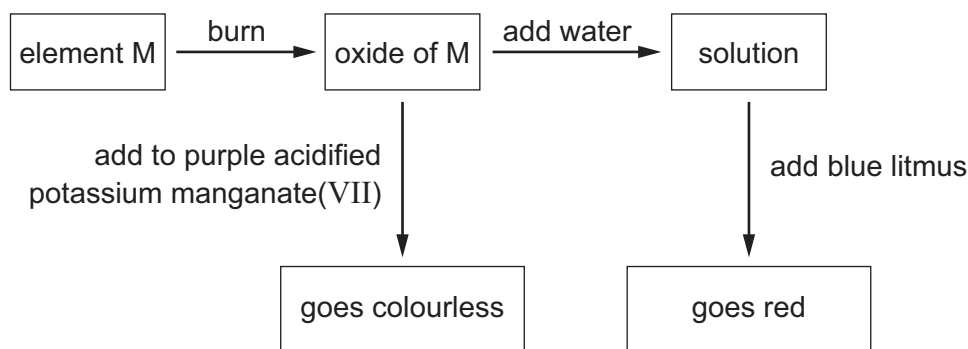

What is element M?

- A carbon
- B iron
- C magnesium
- D sulfur

21 In which equation is the underlined reactant acting as a base?

- A $\text{CH}_3\text{COO}^- + \underline{\text{H}_3\text{O}^+} \rightarrow \text{CH}_3\text{COOH} + \text{H}_2\text{O}$
- B $\underline{\text{NH}_4^+} + \text{OH}^- \rightarrow \text{NH}_3 + \text{H}_2\text{O}$
- C $\text{CO}_2 + 2\underline{\text{H}_2\text{O}} \rightarrow \text{H}_3\text{O}^+ + \text{HCO}_3^-$
- D $\underline{\text{H}^+} + \text{OH}^- \rightarrow \text{H}_2\text{O}$

22 Why is helium used to fill balloons?

- A Helium is monoatomic.
- B Helium is in Group VIII of the Periodic Table.
- C Helium has a full outer electron shell.
- D Helium is less dense than air.

23 Which elements in the table are transition elements?

element	property
E	forms E^{3+} ions only
F	forms F^+ and F^{2+} ions
G	forms only white salts
H	used in catalytic converters

- A E and G
- B E and H
- C F and G
- D F and H

24 Element R forms a covalent compound R_2Si with silicon.

Which row describes R?

	metallic or non-metallic character	group number in the Periodic Table
A	metallic	II
B	metallic	VI
C	non-metallic	II
D	non-metallic	VI

25 Some properties of metal J are listed.

- J does not react with cold water.
- J reacts with dilute hydrochloric acid.
- No reaction occurs when the oxide of J is heated with carbon.

What is J?

- A** copper
- B** iron
- C** magnesium
- D** sodium

26 Some metal nitrates and carbonates decompose when heated strongly.

Metal Q has a nitrate that decomposes to give a salt and a colourless gas only.

The carbonate of metal Q does not decompose when heated with a Bunsen burner.

What is metal Q?

- A** calcium
- B** copper
- C** sodium
- D** zinc

27 Which substances are used in the extraction of aluminium?

- A bauxite and cryolite
- B bauxite and hematite
- C cryolite and zinc blende
- D hematite and zinc blende

28 Different types of steel alloys are manufactured by changing the percentage of carbon in the alloy.

The properties of four steel alloys are shown.

alloy mixture	percentage of carbon in the alloy	strength of the alloy	hardness of the alloy
1	0.00 to 0.20	high	low
2	0.21 to 0.30	high	medium
3	0.31 to 0.40	medium	high
4	0.41 to 1.50	low	high

What are the properties of the steel alloy containing 0.23% of carbon?

	strength	hardness
A	high	low
B	low	high
C	high	medium
D	medium	high

29 Ammonia is made by reacting nitrogen with hydrogen in the Haber process.

The equation for the process is shown.

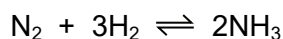

Which changes in reaction conditions would produce a greater yield of ammonia?

- 1 adding more iron catalyst
- 2 increasing the reaction pressure
- 3 increasing the particle size of the iron catalyst

- A** 1 only
- B** 2 only
- C** 1 and 2
- D** 2 and 3

- 30 Which process removes carbon dioxide from the atmosphere?
- A combustion of fossil fuels
 - B fermentation
 - C photosynthesis
 - D respiration
- 31 Which catalyst is used in the Contact process?
- A calcium oxide
 - B iron
 - C manganese(II) oxide
 - D vanadium(V) oxide
- 32 A white solid Z reacts with dilute hydrochloric acid to produce a gas.
The same gas is produced when compound Z is heated strongly.
What is Z?
- A calcium
 - B calcium carbonate
 - C calcium hydroxide
 - D calcium oxide
- 33 What is the structure of butanoic acid?
- A $\text{CH}_3\text{CH}_2\text{CO}_2\text{H}$
 - B $\text{CH}_3\text{CH}_2\text{CH}_2\text{CO}_2\text{H}$
 - C $\text{CH}_3\text{CH}_2\text{CH}_2\text{CH}_2\text{CO}_2\text{H}$
 - D $\text{CH}_3\text{CH}_2\text{CH}_2\text{CO}_2\text{CH}_3$

34 Compound Z contains carbon, hydrogen and oxygen.

Molecules of compound Z have four hydrogen atoms and two carbon atoms.

Compound Z can be made by oxidation of an alcohol.

What is compound Z?

- A** ethene
- B** ethanol
- C** ethanoic acid
- D** methyl methanoate

35 Which statement about homologous series and isomerism is correct?

- A** Butane and butene are structural isomers.
- B** Compounds in the same homologous series have the same general formula.
- C** Compounds in the same homologous series have the same molecular formula.
- D** Structural isomers have different molecular formulae.

36 Which statement about alkanes is correct?

- A** They burn in oxygen.
- B** They contain carbon, hydrogen and oxygen atoms.
- C** They contain double bonds.
- D** They contain ionic bonds.

37 What is an advantage of manufacturing ethanol by fermentation?

- A** The process is very fast.
- B** The ethanol requires no separation.
- C** The raw materials used are renewable.
- D** There are no other products formed.

38 P, Q, R and S are four organic compounds.

P is an unsaturated hydrocarbon.

Q burns but otherwise is unreactive.

R contains a C–C single bond and a C=C double bond.

S undergoes addition polymerisation.

Which compounds are alkenes?

A P and R only **B** P, R and S **C** P, Q and S **D** Q, R and S

39 The structure of a synthetic polymer is shown.

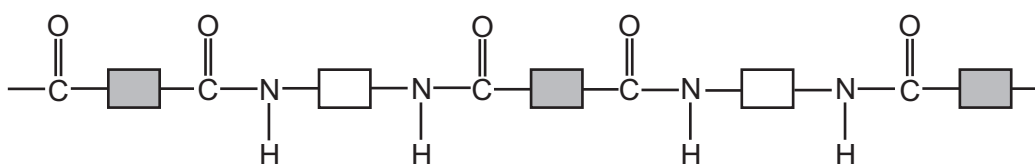

The structure shows that it is a1..... . It is formed by2..... polymerisation.

Which words complete gaps 1 and 2?

	1	2
A	polyamide	addition
B	polyamide	condensation
C	polyester	addition
D	polyester	condensation

40 Which substance is a natural polymer?

- A** ethene
- B** *Terylene*
- C** nylon
- D** protein

BLANK PAGE

BLANK PAGE

Permission to reproduce items where third-party owned material protected by copyright is included has been sought and cleared where possible. Every reasonable effort has been made by the publisher (UCLES) to trace copyright holders, but if any items requiring clearance have unwittingly been included, the publisher will be pleased to make amends at the earliest possible opportunity.

To avoid the issue of disclosure of answer-related information to candidates, all copyright acknowledgements are reproduced online in the Cambridge Assessment International Education Copyright Acknowledgements Booklet. This is produced for each series of examinations and is freely available to download at www.cambridgeinternational.org after the live examination series.

Cambridge Assessment International Education is part of the Cambridge Assessment Group. Cambridge Assessment is the brand name of the University of Cambridge Local Examinations Syndicate (UCLES), which itself is a department of the University of Cambridge.

The Periodic Table of Elements

		Group																
I	II											III	IV	V	VI	VII	VIII	
3 Li lithium 7	4 Be beryllium 9	Key atomic number atomic symbol name relative atomic mass											5 B boron 11	6 C carbon 12	7 N nitrogen 14	8 O oxygen 16	9 F fluorine 19	10 Ne neon 20
11 Na sodium 23	12 Mg magnesium 24												1 H hydrogen 1	13 Al aluminium 27	14 Si silicon 28	15 P phosphorus 31	16 S sulfur 32	17 Cl chlorine 35.5
19 K potassium 39	20 Ca calcium 40	21 Sc scandium 45	22 Ti titanium 48	23 V vanadium 51	24 Cr chromium 52	25 Mn manganese 55	26 Fe iron 56	27 Co cobalt 59	28 Ni nickel 59	29 Cu copper 64	30 Zn zinc 65	31 Ga gallium 70	32 Ge germanium 73	33 As arsenic 75	34 Se selenium 79	35 Br bromine 80	36 Kr krypton 84	
37 Rb rubidium 85	38 Sr strontium 88	39 Y yttrium 89	40 Zr zirconium 91	41 Nb niobium 93	42 Mo molybdenum 96	43 Tc technetium —	44 Ru ruthenium 101	45 Rh rhodium 103	46 Pd palladium 106	47 Ag silver 108	48 Cd cadmium 112	49 In indium 115	50 Sn tin 119	51 Sb antimony 122	52 Te tellurium 128	53 I iodine 127	54 Xe xenon 131	
55 Cs caesium 133	56 Ba barium 137	57–71 lanthanoids	72 Hf hafnium 178	73 Ta tantalum 181	74 W tungsten 184	75 Re rhenium 186	76 Os osmium 190	77 Ir iridium 192	78 Pt platinum 195	79 Au gold 197	80 Hg mercury 201	81 Tl thallium 204	82 Pb lead 207	83 Bi bismuth 209	84 Po polonium —	85 At astatine —	86 Rn radon —	
87 Fr francium —	88 Ra radium —	89–103 actinoids	104 Rf rutherfordium —	105 Db dubnium —	106 Sg seaborgium —	107 Bh bohrium —	108 Hs hassium —	109 Mt meitnerium —	110 Ds darmstadtium —	111 Rg roentgenium —	112 Cn copernicium —	114 Fl flerovium —	116 Lv livermorium —	—	—	—	—	
lanthanoids		57 La lanthanum 139	58 Ce cerium 140	59 Pr praseodymium 141	60 Nd neodymium 144	61 Pm promethium —	62 Sm samarium 150	63 Eu europium 152	64 Gd gadolinium 157	65 Tb terbium 159	66 Dy dysprosium 163	67 Ho holmium 165	68 Er erbium 167	69 Tm thulium 169	70 Yb ytterbium 173	71 Lu lutetium 175	—	
actinoids		89 Ac actinium —	90 Th thorium 232	91 Pa protactinium 231	92 U uranium 238	93 Np neptunium —	94 Pu plutonium —	95 Am americium —	96 Cm curium —	97 Bk berkelium —	98 Cf californium —	99 Es einsteinium —	100 Fm fermium —	101 Md mendelevium —	102 No nobelium —	103 Lr lawrencium —	—	

The volume of one mole of any gas is 24 dm³ at room temperature and pressure (r.t.p.).