

Cambridge IGCSE™

CANDIDATE
NAME

CENTRE
NUMBER

--	--	--	--	--

CANDIDATE
NUMBER

--	--	--	--

CHEMISTRY

0620/61

Paper 6 Alternative to Practical

May/June 2021

1 hour

You must answer on the question paper.

No additional materials are needed.

INSTRUCTIONS

- Answer **all** questions.
- Use a black or dark blue pen. You may use an HB pencil for any diagrams or graphs.
- Write your name, centre number and candidate number in the boxes at the top of the page.
- Write your answer to each question in the space provided.
- Do **not** use an erasable pen or correction fluid.
- Do **not** write on any bar codes.
- You may use a calculator.
- You should show all your working and use appropriate units.

INFORMATION

- The total mark for this paper is 40.
- The number of marks for each question or part question is shown in brackets [].

This document has **12** pages. Any blank pages are indicated.



1 Many indicators are coloured substances obtained from plants.

A student extracted the coloured substances from some berries using the method shown.

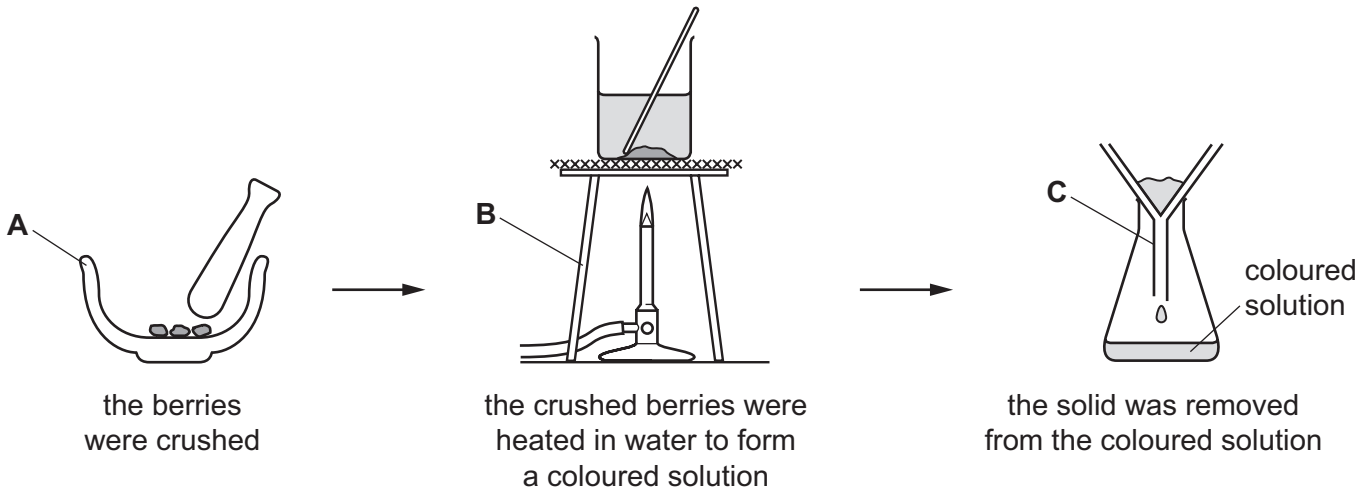

(a) Name the items of apparatus labelled **A**, **B** and **C**.

A

B

C

[3]

(b) The student analysed the coloured solution using chromatography.

(i) Complete the diagram to show:

- where the spot of coloured solution should be placed on the paper
- the level of the solvent in the beaker.

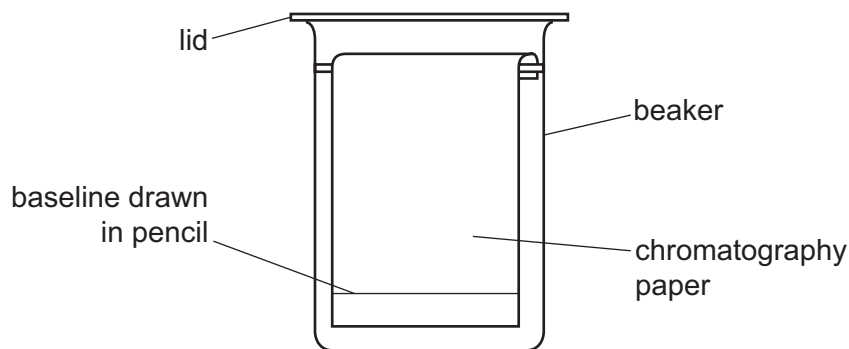

[2]

(ii) Explain why pencil is used to draw the baseline on the chromatography paper.

.....

..... [1]

- (c) The student made two chromatograms. After chromatography, one chromatogram was dipped in dilute hydrochloric acid and one was dipped in aqueous sodium hydroxide.

The results are shown.

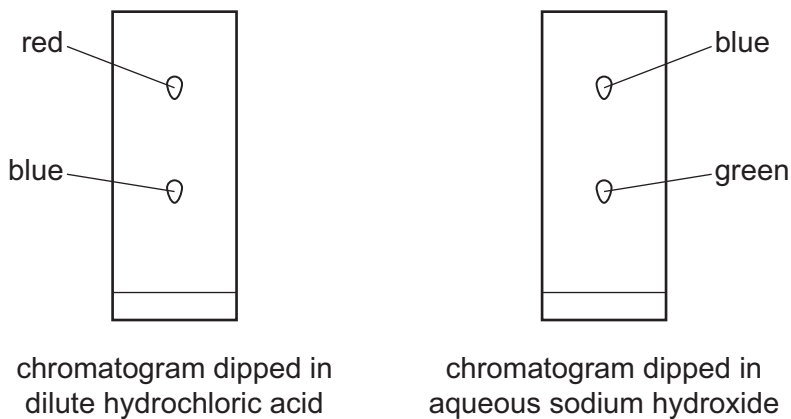

- (i) Determine the number of coloured substances in the solution obtained from the berries.

..... [1]

- (ii) The table gives the colours of some indicators in acid and alkali.

name of indicator	colour in acid	colour in alkali
anthocyanin	red	blue
bromothymol blue	yellow	blue
congo red	blue	red
methyl purple	purple	green

Use the data in the table and the results to give a possible identity for **one** indicator in the berries.

..... [1]

[Total: 8]

BLANK PAGE

- 2 A student investigated the temperature decrease when sodium hydrogencarbonate reacts with dilute hydrochloric acid.

The student did six experiments.

Experiment 1

- Using a measuring cylinder, 25 cm³ of dilute hydrochloric acid was poured into a conical flask.
- The initial temperature of the acid was measured using a thermometer.
- 1 g of sodium hydrogencarbonate was added to the conical flask. At the same time a stop-clock was started.
- The acid and sodium hydrogencarbonate mixture in the conical flask was stirred continuously using the thermometer.
- The temperature of the mixture after 1 minute was measured.
- The conical flask was rinsed with distilled water.

Experiment 2

- Experiment 1 was repeated using 2 g of sodium hydrogencarbonate instead of 1 g.

Experiment 3

- Experiment 1 was repeated using 3 g of sodium hydrogencarbonate instead of 1 g.

Experiment 4

- Experiment 1 was repeated using 5 g of sodium hydrogencarbonate instead of 1 g.

Experiment 5

- Experiment 1 was repeated using 6 g of sodium hydrogencarbonate instead of 1 g.

Experiment 6

- Experiment 1 was repeated using 7 g of sodium hydrogencarbonate instead of 1 g.

(a) Use the thermometer diagrams to complete the table and calculate the temperature decreases.

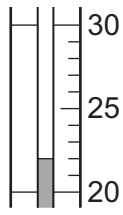
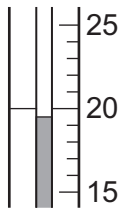
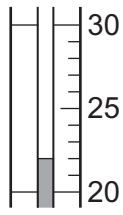
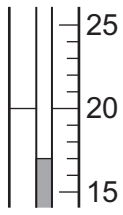
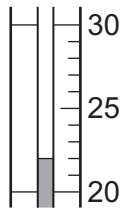
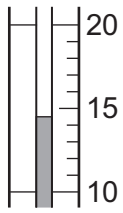
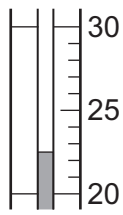
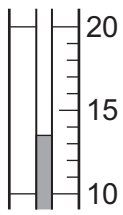
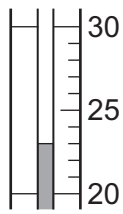
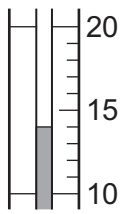
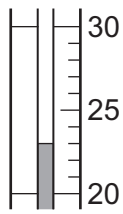
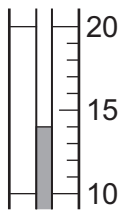
experiment	mass of sodium hydrogencarbonate /g	thermometer diagram	initial temperature of acid /°C	thermometer diagram	temperature after 1 minute /°C	temperature decrease /°C
1	1					
2	2					
3	3					
4	5					
5	6					
6	7					

[4]

(b) Plot the results from Experiments 1 to 6 on the grid.

Draw **two** best-fit straight lines through your points. The first straight line should be for the first three points and must pass through (0,0). The second straight line should be for the last three points and must be horizontal. Extend your straight lines so that they meet each other.

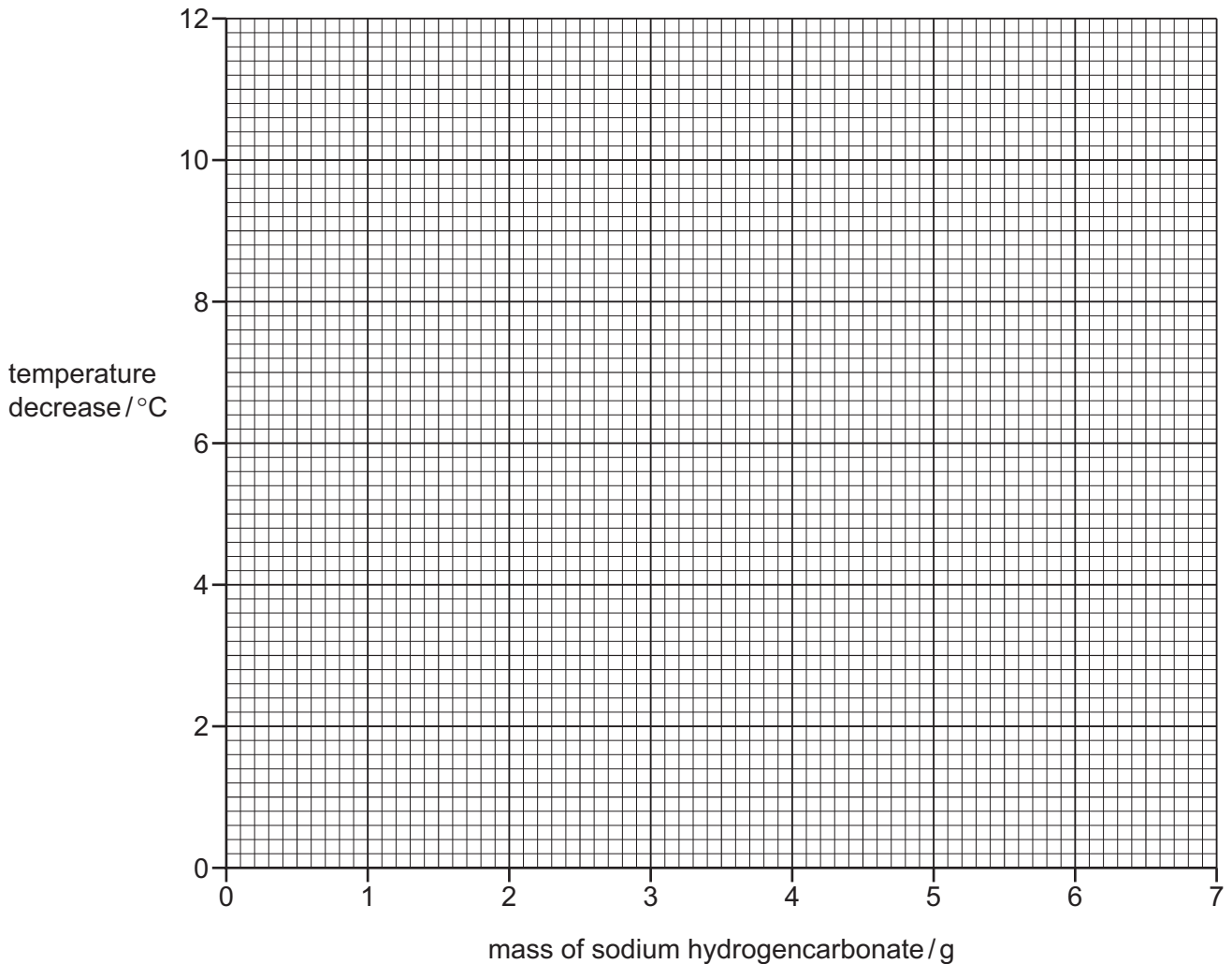

[4]

(c) (i) **From your graph**, determine the temperature decrease and mass of sodium hydrogencarbonate where your two straight lines meet. Include appropriate units in your answer.

Show clearly **on the grid** how you worked out your answer.

temperature decrease =

mass of sodium hydrogencarbonate =

[3]

(ii) Explain why the temperature decrease becomes constant for high masses of sodium hydrogencarbonate.

.....
 [1]

- (d) The investigation was repeated with dilute hydrochloric acid of half the concentration, but the same volume.

Sketch **on the grid** the graph you would expect to obtain.

Label your line **D**. [2]

- (e) Suggest **two** changes that could be made to the apparatus that would improve the accuracy of the results. For each change explain why it would improve the accuracy of the results.

change 1

explanation 1

.....

change 2

explanation 2

.....

[4]

[Total: 18]

- 3 Solid **E** and solution **F** were analysed.
Tests were done on each substance.

tests on solid E

tests	observations
<p>test 1</p> <p>About half of solid E was placed in a test-tube and heated gently.</p>	<p>steam was given off; condensation appeared near the mouth of the test-tube</p>
<p>The remaining solid E was dissolved in distilled water to produce solution E. The solution was divided into four equal portions in three test-tubes and a boiling tube.</p> <p>test 2</p> <p>About 1 cm³ of dilute nitric acid followed by a few drops of aqueous silver nitrate were added to the first portion of solution E.</p>	<p>no visible change</p>
<p>test 3</p> <p>About 1 cm³ of dilute nitric acid followed by a few drops of aqueous barium nitrate were added to the second portion of solution E.</p>	<p>white precipitate</p>
<p>test 4</p> <p>Excess aqueous ammonia was added to the third portion of solution E.</p>	<p>white precipitate</p>
<p>test 5</p> <p>Aqueous sodium hydroxide was added dropwise and then in excess to the fourth portion of solution E in the boiling tube.</p>	<p>white precipitate which dissolved in excess to form a colourless solution</p>
<p>test 6</p> <p>The product from test 5 was warmed gently and any gas given off was tested with damp red litmus paper.</p>	<p>the red litmus paper turned blue</p>

- (a) State the conclusion that can be made from the observations in **test 1**.

.....
 [1]

- (b) State the conclusion that can be made from the observation in **test 2**.

.....
 [1]

(c) Identify the **three** ions in solid **E**.

.....
..... [3]

tests on solution F

Solution **F** was aqueous sodium hydroxide.

Complete the expected observations.

(d) A flame test was carried out on solution **F**.

observations [1]

(e) The remaining solution **F** was divided into two approximately equal portions in two test-tubes.

(i) To the first portion of solution **F** a few drops of universal indicator solution were added.

observations [1]

(ii) To the second portion of solution **F** approximately 2 cm³ of aqueous copper(II) sulfate was added.

observations [1]

[Total: 8]

Permission to reproduce items where third-party owned material protected by copyright is included has been sought and cleared where possible. Every reasonable effort has been made by the publisher (UCLES) to trace copyright holders, but if any items requiring clearance have unwittingly been included, the publisher will be pleased to make amends at the earliest possible opportunity.

To avoid the issue of disclosure of answer-related information to candidates, all copyright acknowledgements are reproduced online in the Cambridge Assessment International Education Copyright Acknowledgements Booklet. This is produced for each series of examinations and is freely available to download at www.cambridgeinternational.org after the live examination series.

Cambridge Assessment International Education is part of the Cambridge Assessment Group. Cambridge Assessment is the brand name of the University of Cambridge Local Examinations Syndicate (UCLES), which itself is a department of the University of Cambridge.