



UNIVERSITY OF CAMBRIDGE INTERNATIONAL EXAMINATIONS
International General Certificate of Secondary Education

MATHEMATICS

0580/04, 0581/04

Paper 4 (Extended)

May/June 2007

2 hours 30 minutes

Additional Materials: Answer Booklet/Paper
Electronic calculator
Geometrical instruments

Graph paper (2 sheets)
Mathematical tables (optional)
Tracing paper (optional)

* 5 1 2 8 6 1 5 9 4 9 *



READ THESE INSTRUCTIONS FIRST

If you have been given an Answer Booklet, follow the instructions on the front cover of the Booklet.

Write your Centre number, candidate number and name on all the work you hand in.

Write in dark blue or black pen.

You may use a pencil for any diagrams or graphs.

Do not use staples, paper clips, highlighters, glue or correction fluid.

Answer **all** questions.

All working must be clearly shown. It should be done on the same sheet as the rest of the answer.

Marks will be given for working which shows that you know how to solve the problem even if you get the answer wrong.

Electronic calculators should be used.

If the degree of accuracy is not specified in the question, and if the answer is not exact, give the answer to three significant figures.

Give answers in degrees to one decimal place.

For π use either your calculator value or 3.142.

At the end of the examination, fasten all your work securely together.

The number of marks is given in brackets [] at the end of each question or part question.

The total of the marks for this paper is 130.

This document consists of **11** printed pages and **1** blank page.



DO NOT WRITE YOUR ANSWERS ON THIS QUESTION PAPER.

WRITE ALL YOUR WORKING AND ANSWERS ON THE SEPARATE ANSWER BOOK OR PAPER PROVIDED.

- 1 (a) The scale of a map is 1:20 000 000.

On the map, the distance between Cairo and Addis Ababa is 12 cm.

- (i) Calculate the distance, in kilometres, between Cairo and Addis Ababa. [2]

- (ii) On the map the area of a desert region is 13 square centimetres.

Calculate the actual area of this desert region, in square kilometres. [2]

- (b) (i) The actual distance between Cairo and Khartoum is 1580 km.

On a different map this distance is represented by 31.6 cm.

Calculate, in the form 1 : n , the scale of this map. [2]

- (ii) A plane flies the 1580 km from Cairo to Khartoum.

It departs from Cairo at 11 55 and arrives in Khartoum at 14 03.

Calculate the average speed of the plane, in kilometres per hour. [4]

2

Answer the whole of this question on a sheet of graph paper.

- (a) Draw and label x and y axes from -6 to 6 , using a scale of 1 cm to 1 unit. [1]
- (b) Draw triangle ABC with $A(2,1)$, $B(3,3)$ and $C(5,1)$. [1]
- (c) Draw the reflection of triangle ABC in the line $y = x$. Label this $A_1B_1C_1$. [2]
- (d) Rotate **triangle** $A_1B_1C_1$ about $(0,0)$ through 90° anti-clockwise. Label this $A_2B_2C_2$. [2]
- (e) Describe fully the single transformation which maps triangle ABC onto triangle $A_2B_2C_2$. [2]
- (f) A transformation is represented by the matrix $\begin{pmatrix} 1 & 0 \\ -1 & 1 \end{pmatrix}$.
- (i) Draw the image of triangle ABC under this transformation. Label this $A_3B_3C_3$. [3]
- (ii) Describe fully the single transformation represented by the matrix $\begin{pmatrix} 1 & 0 \\ -1 & 1 \end{pmatrix}$. [2]
- (iii) Find the matrix which represents the transformation that maps triangle $A_3B_3C_3$ onto triangle ABC . [2]
-

3 (a)

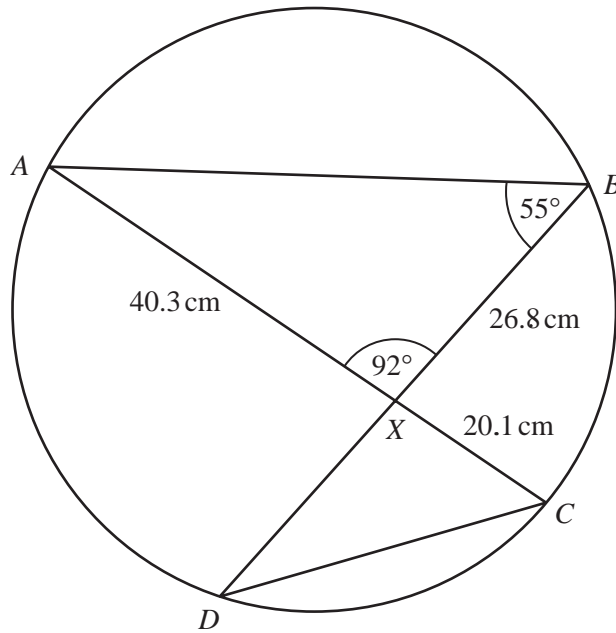
NOT TO
SCALE

A, B, C and D lie on a circle.

AC and BD intersect at X .

Angle $ABX = 55^\circ$ and angle $AXB = 92^\circ$.

$BX = 26.8$ cm, $AX = 40.3$ cm and $XC = 20.1$ cm.

- (i) Calculate the area of triangle AXB .
You must show your working. [2]
- (ii) Calculate the length of AB .
You must show your working. [3]
- (iii) Write down the size of angle ACD . Give a reason for your answer. [2]
- (iv) Find the size of angle BDC . [1]
- (v) Write down the geometrical word which completes the statement
“Triangle AXB is _____ to triangle DXC .” [1]
- (vi) Calculate the length of XD .
You must show your working. [2]

(b)

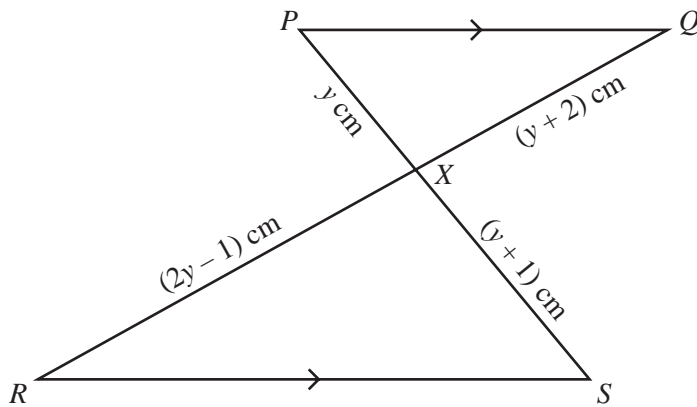
NOT TO
SCALE

In the diagram PQ is parallel to RS .

PS and QR intersect at X .

$PX = y$ cm, $QX = (y + 2)$ cm, $RX = (2y - 1)$ cm and $SX = (y + 1)$ cm.

(i) Show that $y^2 - 4y - 2 = 0$. [3]

(ii) Solve the equation $y^2 - 4y - 2 = 0$.

Show all your working and give your answers correct to two decimal places. [4]

(iii) Write down the length of RX . [1]

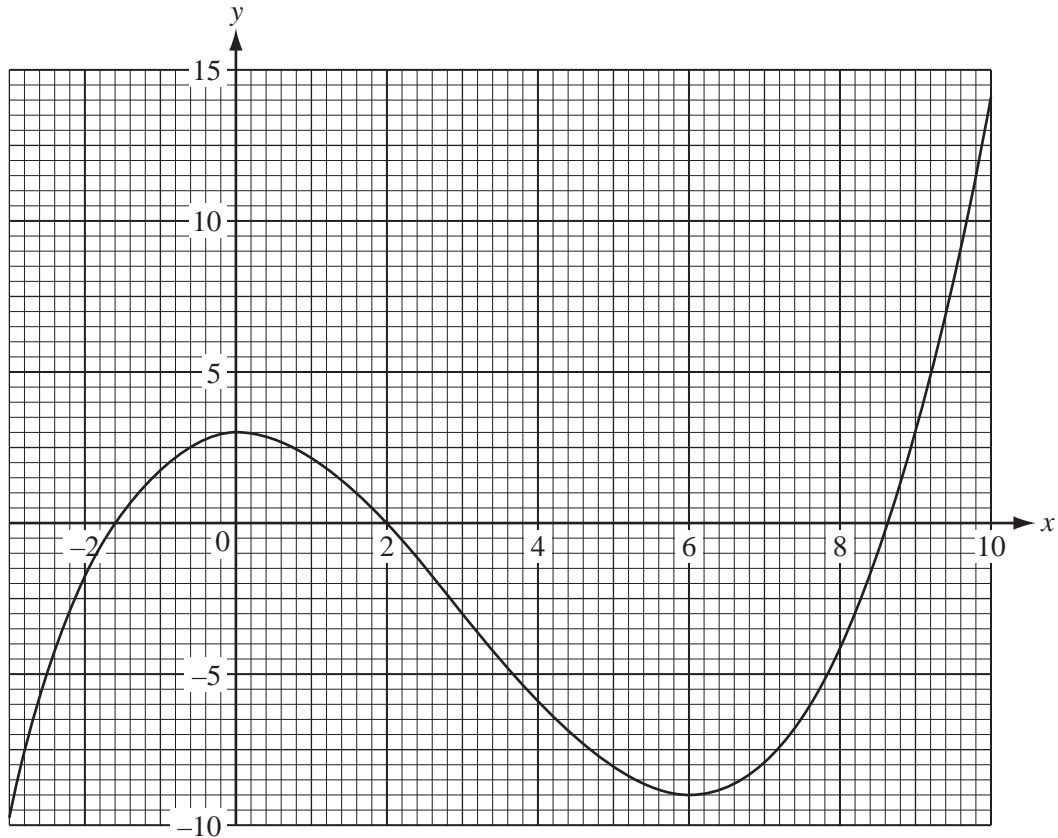

The diagram shows the accurate graph of $y = f(x)$.

(a) Use the graph to find

(i) $f(0)$, [1]

(ii) $f(8)$. [1]

(b) Use the graph to solve

(i) $f(x) = 0$, [2]

(ii) $f(x) = 5$. [1]

(c) k is an integer for which the equation $f(x) = k$ has exactly two solutions.

Use the graph to find the two values of k . [2]

(d) Write down the range of values of x for which the graph of $y = f(x)$ has a negative gradient. [2]

(e) The equation $f(x) + x - 1 = 0$ can be solved by drawing a line on the grid.

(i) Write down the equation of this line. [1]

(ii) How many solutions are there for $f(x) + x - 1 = 0$? [1]

5

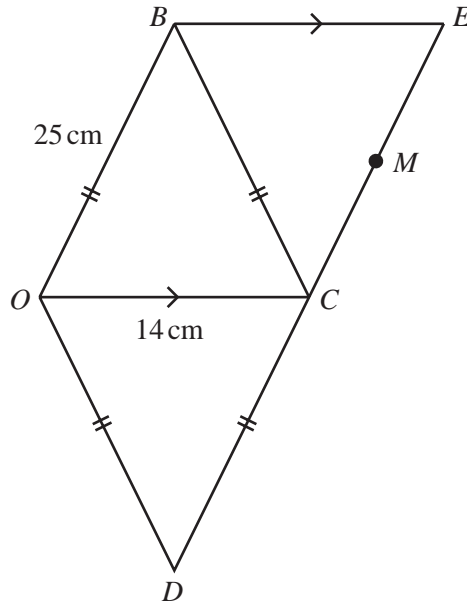
NOT TO
SCALE

$OBCD$ is a rhombus with sides of 25 cm. The length of the diagonal OC is 14 cm.

- (a) Show, **by calculation**, that the length of the diagonal BD is 48 cm. [3]
- (b) Calculate, correct to the nearest degree,
- (i) angle BCD , [2]
- (ii) angle OBC . [1]
- (c) $\vec{DB} = 2\mathbf{p}$ and $\vec{OC} = 2\mathbf{q}$.
Find, in terms of \mathbf{p} and \mathbf{q} ,
- (i) \vec{OB} , [1]
- (ii) \vec{OD} . [1]
- (d) BE is parallel to OC and DCE is a straight line.
Find, in its simplest form, \vec{OE} in terms of \mathbf{p} and \mathbf{q} . [2]
- (e) M is the mid-point of CE .
Find, in its simplest form, \vec{OM} in terms of \mathbf{p} and \mathbf{q} . [2]
- (f) O is the origin of a co-ordinate grid. OC lies along the x -axis and $\mathbf{q} = \begin{pmatrix} 7 \\ 0 \end{pmatrix}$.
(\vec{DB} is vertical and $|\vec{DB}| = 48$.)
Write down as column vectors
- (i) \mathbf{p} , [1]
- (ii) \vec{BC} . [2]
- (g) Write down the value of $|\vec{DE}|$. [1]

6 Answer the whole of this question on a sheet of graph paper.

Kristina asked 200 people how much water they drink in one day.

The table shows her results.

Amount of water (x litres)	Number of people
$0 < x \leq 0.5$	8
$0.5 < x \leq 1$	27
$1 < x \leq 1.5$	45
$1.5 < x \leq 2$	50
$2 < x \leq 2.5$	39
$2.5 < x \leq 3$	21
$3 < x \leq 3.5$	7
$3.5 < x \leq 4$	3

- (a) Write down the modal interval. [1]
- (b) Calculate an estimate of the mean. [4]
- (c) Make a cumulative frequency table for this data. [2]
- (d) Using a scale of 4 cm to 1 litre of water on the horizontal axis and 1 cm to 10 people on the vertical axis, draw the cumulative frequency graph. [5]
- (e) Use your cumulative frequency graph to find
- (i) the median, [1]
 - (ii) the 40th percentile, [1]
 - (iii) the number of people who drink at least 2.6 litres of water. [2]
- (f) A doctor recommends that a person drinks at least 1.8 litres of water each day. What percentage of these 200 people do not drink enough water? [2]
-

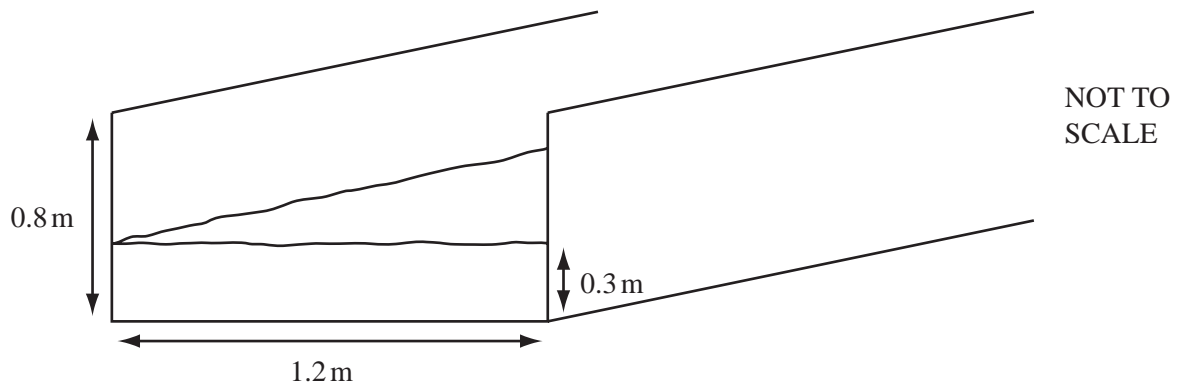

The diagram shows water in a channel.

This channel has a rectangular cross-section, 1.2 metres by 0.8 metres.

- (a) When the depth of water is 0.3 metres, the water flows along the channel at 3 metres/**minute**.

Calculate the number of cubic metres which flow along the channel in one hour. [3]

- (b) When the depth of water in the channel increases to 0.8 metres, the water flows at 15 metres/minute.

Calculate the percentage increase in the number of cubic metres which flow along the channel in one hour. [4]

- (c) The water comes from a cylindrical tank.

When 2 cubic metres of water leave the tank, the level of water in the tank goes down by 1.3 **millimetres**.

Calculate the radius of the tank, in **metres**, correct to one decimal place. [4]

- (d) When the channel is empty, its **interior** surface is repaired.

This costs \$0.12 per square metre. The total cost is \$50.40.

Calculate the length, in metres, of the channel. [4]

8 A packet of sweets contains chocolates and toffees.

(a) There are x chocolates which have a total mass of 105 grams.

Write down, in terms of x , the mean mass of a chocolate. [1]

(b) There are $x + 4$ toffees which have a total mass of 105 grams.

Write down, in terms of x , the mean mass of a toffee. [1]

(c) The difference between the two mean masses in **parts (a) and (b)** is 0.8 grams.

Write down an equation in x and show that it simplifies to $x^2 + 4x - 525 = 0$. [4]

(d) (i) Factorise $x^2 + 4x - 525$. [2]

(ii) Write down the solutions of $x^2 + 4x - 525 = 0$. [1]

(e) Write down the total number of sweets in the packet. [1]

(f) Find the mean mass of a sweet in the packet. [2]

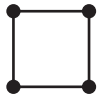

Diagram 1

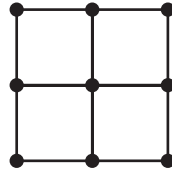

Diagram 2

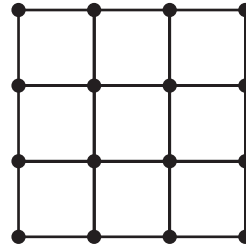

Diagram 3

The first three diagrams in a sequence are shown above.

The diagrams are made up of dots and lines. Each line is one centimetre long.

(a) Make a sketch of the next diagram in the sequence. [1]

(b) The table below shows some information about the diagrams.

Diagram	1	2	3	4	-----	n
Area	1	4	9	16	-----	x
Number of dots	4	9	16	p	-----	y
Number of one centimetre lines	4	12	24	q	-----	z

(i) Write down the values of p and q . [2]

(ii) Write down each of x , y and z in terms of n . [4]

(c) The **total** number of one centimetre lines in the first n diagrams is given by the expression

$$\frac{2}{3}n^3 + fn^2 + gn.$$

(i) Use $n = 1$ in this expression to show that $f + g = \frac{10}{3}$. [1]

(ii) Use $n = 2$ in this expression to show that $4f + 2g = \frac{32}{3}$. [2]

(iii) Find the values of f and g . [3]

(iv) Find the total number of one centimetre lines in the first 10 diagrams. [1]

BLANK PAGE

Permission to reproduce items where third-party owned material protected by copyright is included has been sought and cleared where possible. Every reasonable effort has been made by the publisher (UCLES) to trace copyright holders, but if any items requiring clearance have unwittingly been included, the publisher will be pleased to make amends at the earliest possible opportunity.

University of Cambridge International Examinations is part of the Cambridge Assessment Group. Cambridge Assessment is the brand name of University of Cambridge Local Examinations Syndicate (UCLES), which is itself a department of the University of Cambridge.