

International General Certificate of Secondary Education
CAMBRIDGE INTERNATIONAL EXAMINATIONS

PHYSICS

0625/1

PAPER 1 Multiple Choice

OCTOBER/NOVEMBER SESSION 2002

45 minutes

Additional materials:

Multiple Choice answer sheet

Soft clean eraser

Soft pencil (type B or HB is recommended)

TIME 45 minutes

INSTRUCTIONS TO CANDIDATES

Do not open this booklet until you are told to do so.

Write your name, Centre number and candidate number on the answer sheet in the spaces provided unless this has already been done for you.

There are **forty** questions in this paper. Answer **all** questions. For each question, there are four possible answers, **A**, **B**, **C** and **D**. Choose the **one** you consider correct and record your choice in **soft pencil** on the separate answer sheet.

Read very carefully the instructions on the answer sheet.

INFORMATION FOR CANDIDATES

Each correct answer will score one mark. A mark will not be deducted for a wrong answer.

Any rough working should be done in this booklet.

This question paper consists of 18 printed pages and 2 blank pages.



- 1 The diagram shows a stopwatch, originally set at 00:00.

When a car was first seen, the stop-start button was pressed. When the car passed the observer, the stopwatch showed 01:06.

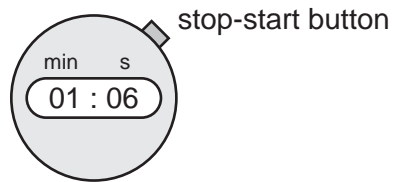

How long did the car take to reach the observer?

- A 1.06 seconds
B 6 seconds
C 66 seconds
D 106 seconds
- 2 A girl uses a rule to measure the length of a metal rod. Because the end of the rule is damaged, she places one end of the rod at the 1 cm mark as shown.

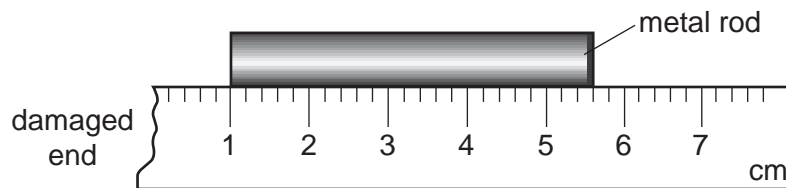

How long is the metal rod?

- A 43 mm B 46 mm C 53 mm D 56 mm

- 3 A stone falls freely from the top of a cliff into the sea. Air resistance may be ignored.

Which graph shows how the acceleration of the stone varies with time as it falls?

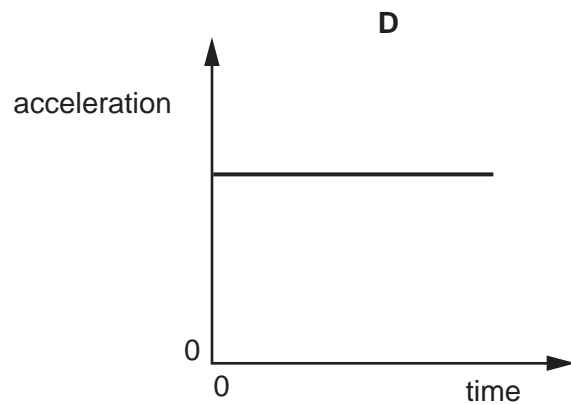
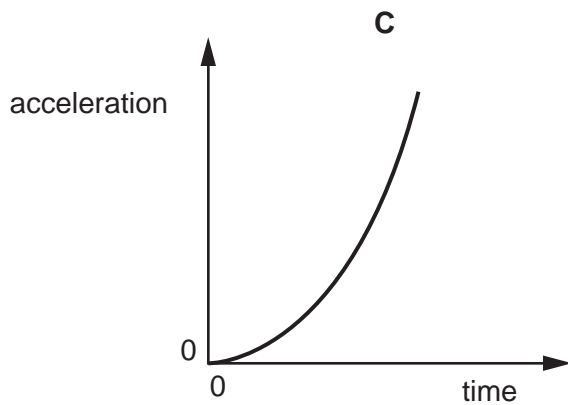
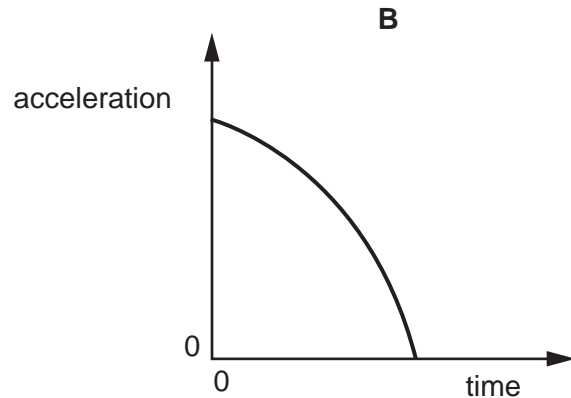
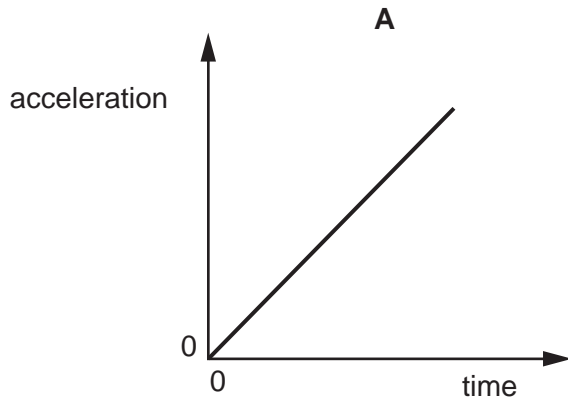

- 4 A child is standing on the platform of a station, watching the trains.

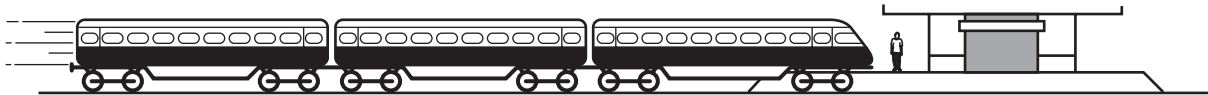

A train travelling at 30 m/s takes 3 s to pass the child.

What is the length of the train?

- A** 10 m **B** 30 m **C** 90 m **D** 270 m
- 5 Which of the following statements is correct?
- A** Mass and weight are different names for the same thing.
- B** The mass of an object is different if the object is taken to the Moon.
- C** The weight of a car is one of the forces acting on the car.
- D** The weight of a chocolate bar is measured in kilograms.

- 6 In an experiment, six identical bags of flour are balanced by a 9 kg mass.

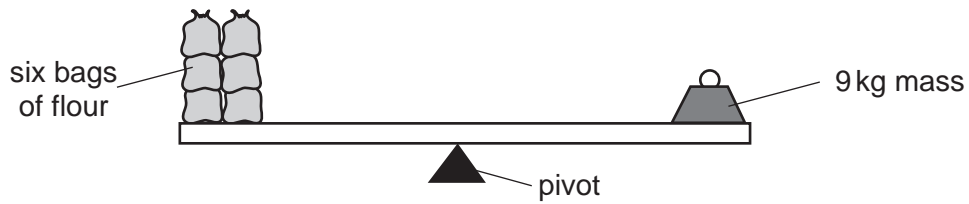

Two bags of flour are removed. What mass will balance the remaining bags?

- A 3 kg B 6 kg C 7 kg D 9 kg
- 7 The masses of a measuring cylinder before and after pouring some liquid are shown in the diagram.

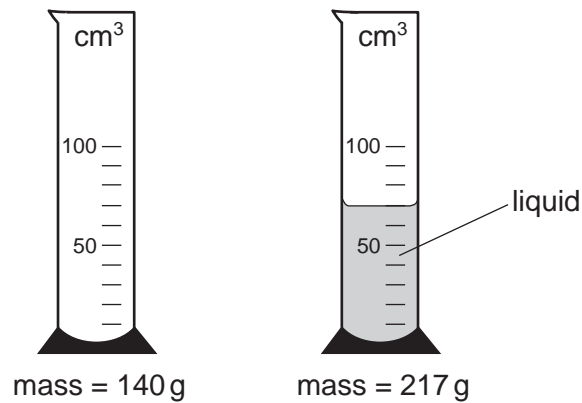

What is the density of the liquid?

- A $\frac{217}{52} \text{ g/cm}^3$ B $\frac{217}{70} \text{ g/cm}^3$ C $\frac{77}{52} \text{ g/cm}^3$ D $\frac{77}{70} \text{ g/cm}^3$
- 8 In which of these situations is no resultant force needed?
- A a car changing direction
 B a car moving in a straight line at a steady speed
 C a car slowing down
 D a car speeding up

- 9 The diagram shows sections of four objects, all of equal mass. The position of the centre of mass of each object has been marked with a cross.

Which object is the most stable?

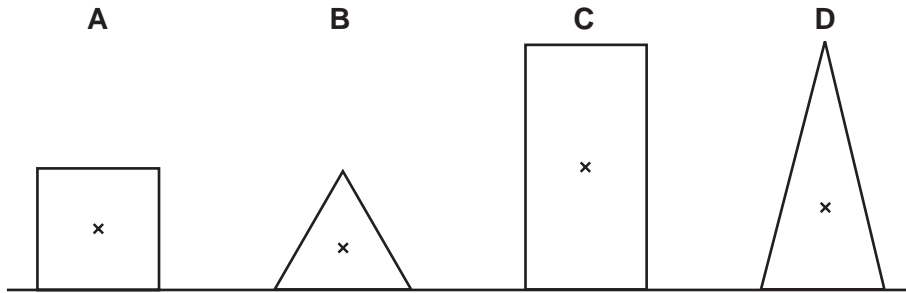

- 10 A car accelerates along a road as it rises uphill.

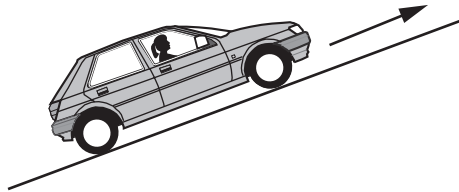

Which energy changes are taking place?

	energy of motion (kinetic energy)	energy of position (gravitational potential energy)
A	decreasing	decreasing
B	decreasing	increasing
C	increasing	decreasing
D	increasing	increasing

- 11 In a car engine, energy stored in the fuel is converted into thermal energy (heat energy) and energy of motion (kinetic energy).

In which form is the energy stored in the fuel?

- A chemical
- B geothermal
- C hydroelectric
- D nuclear

- 12 The diagram shows a simple mercury barometer.

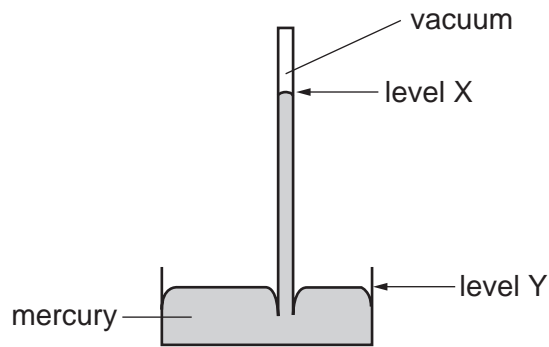

If atmospheric pressure increases, what happens to level X and to level Y?

	level X	level Y
A	goes down	goes down
B	goes down	goes up
C	goes up	goes down
D	goes up	goes up

- 13 Four flower vases have circular bases. They are filled with water so that they all have the same weight.

Which vase exerts the greatest pressure on its base?

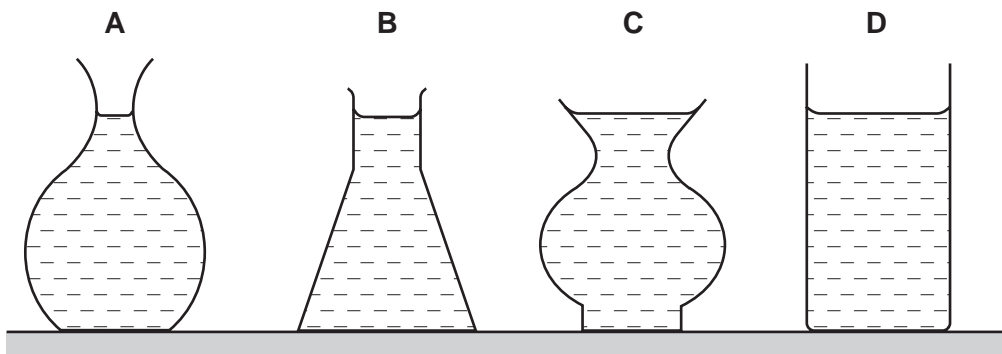

- 14 Some gas in a sealed plastic bag is placed in a refrigerator to cool down.

How do the gas molecules behave when this happens?

- A** They move more quickly and are closer together.
- B** They move more quickly and are further apart.
- C** They move more slowly and are closer together.
- D** They move more slowly and are further apart.

- 15 A measured mass of gas is placed in a cylinder at atmospheric pressure and is then slowly compressed.

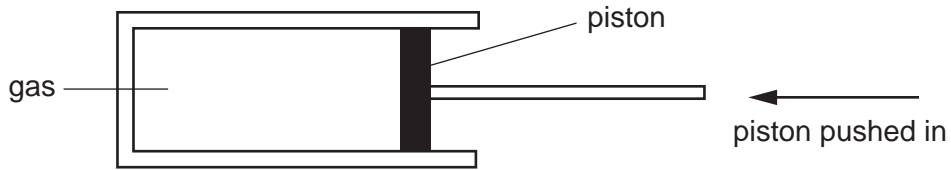

If the temperature of the gas does not change, what happens to the pressure of the gas?

- A It drops to zero.
 - B It decreases, but not to zero.
 - C It stays the same.
 - D It increases.
- 16 A mercury-in-glass thermometer is to be used to measure temperatures from 0 °C to 100 °C.

Why is mercury suitable?

- A Mercury expands when heated.
 - B Mercury has a boiling point below 100 °C.
 - C Mercury has a melting point above 0 °C.
 - D Mercury is a poor conductor.
- 17 A block of ice is heated at a constant rate. Eventually the melted ice boils.

The graph shows how the temperature changes with time.

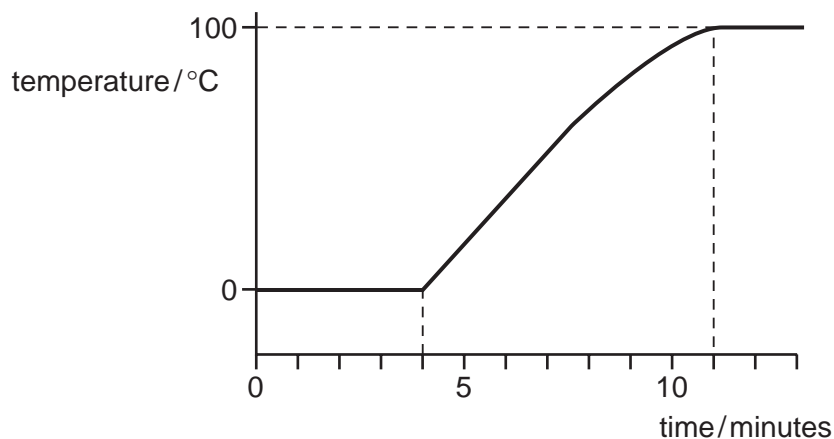

How many minutes did it take to melt all the ice?

- A 4
- B 7
- C 11
- D 13

- 18 How does thermal energy (heat energy) travel through the vacuum between the Earth and the Sun?
- A by conduction
 - B by convection
 - C by radiation
 - D by radioactive decay
- 19 Two plastic cups are placed one inside the other. Hot water is poured into the inner cup and a lid is put on top as shown.

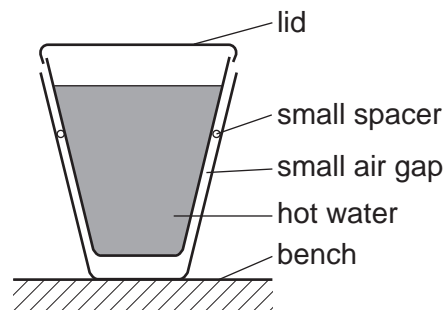

Which statement is correct?

- A Heat loss by radiation is prevented by the small air gap.
- B No heat passes through the sides of either cup.
- C The bench is heated by convection from the bottom of the outer cup.
- D The lid is used to reduce heat loss by convection.

20 Waves are sent along two long springs X and Y as shown.

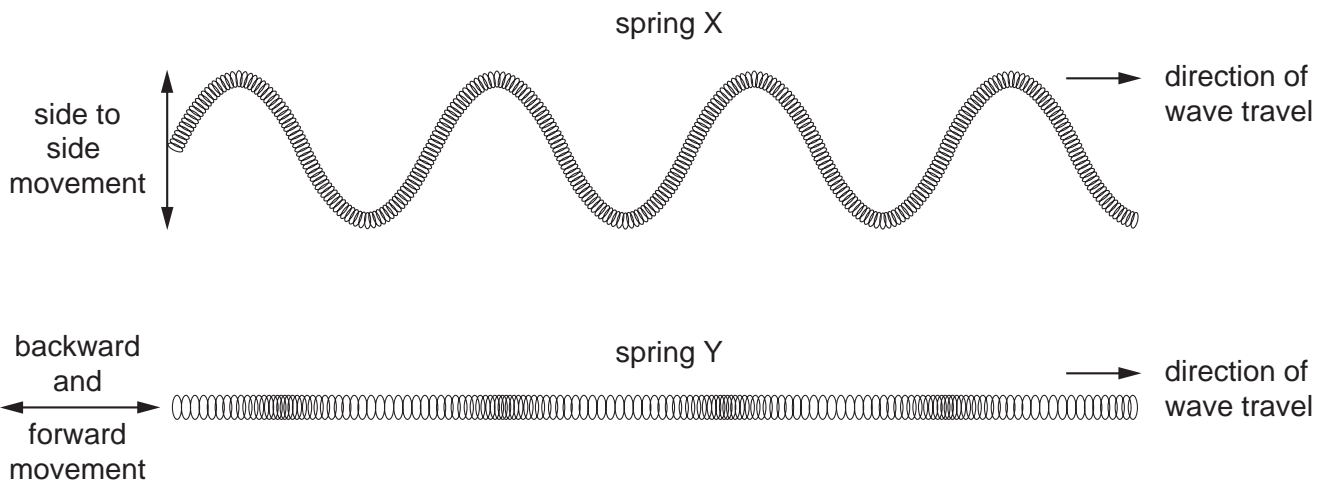

How should the wave motions in X and Y be described?

	spring X	spring Y
A	longitudinal	longitudinal
B	longitudinal	transverse
C	transverse	longitudinal
D	transverse	transverse

21 Radio waves are received at a house at the bottom of a hill.

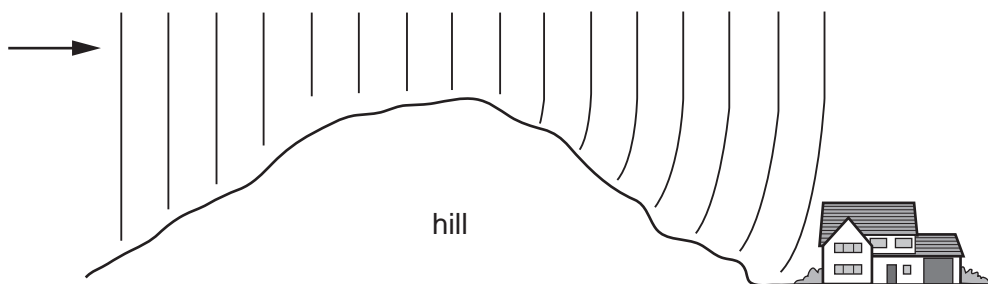

The waves reach the house because the hill has caused them to be

- A** diffracted.
- B** radiated.
- C** reflected.
- D** refracted.

- 22 One of the effects of passing a ray of white light through a prism is to split the light into colours.

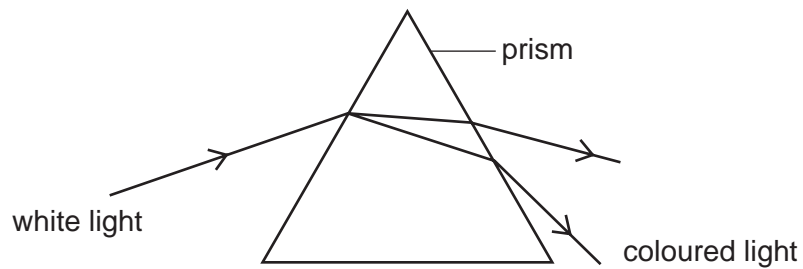

What is the name given to this effect?

- A deviation
 - B dispersion
 - C reflection
 - D refraction
- 23 A student looks at the letter P on a piece of paper, and at its reflection in a mirror.

What does he see?

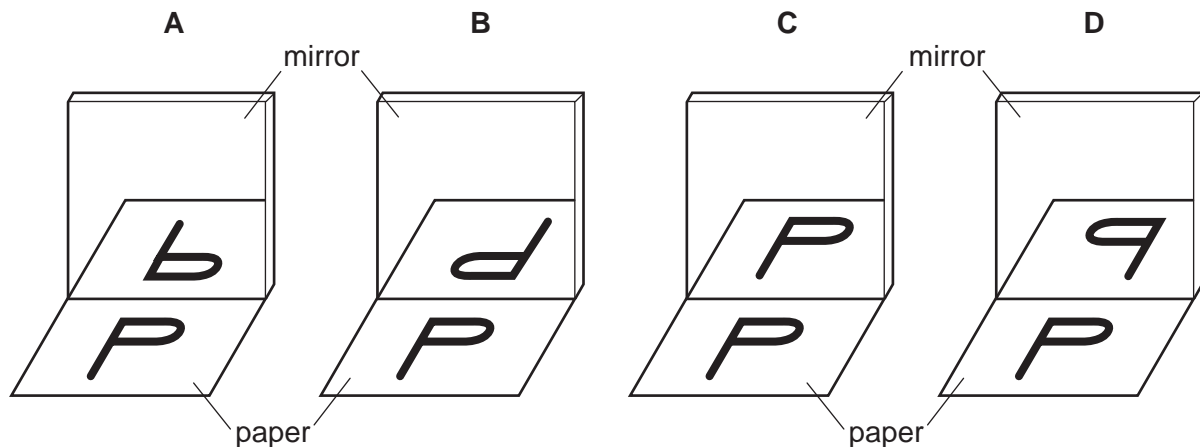

- 24 Which of the following can be heard by the human ear?

- A A whistle emitting a wave of frequency 50 kHz.
- B A bat emitting a wave of frequency of 30 kHz.
- C An insect emitting a wave of 300 Hz.
- D A vibrating spring emitting a wave of frequency of 5 Hz.

- 25 Two sound waves P and Q are displayed on an oscilloscope with the same time-base and Y-plate settings for each.

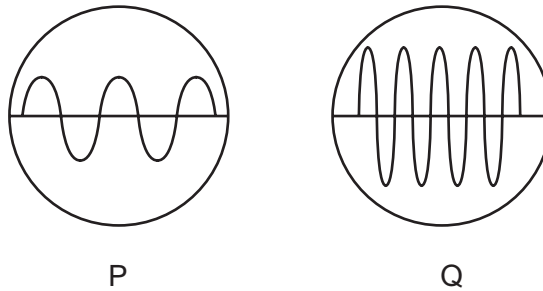

Which statement correctly describes the pitch and the loudness of the two sounds?

- A P has a higher pitch and is louder than Q.
 B P has a higher pitch and is quieter than Q.
 C P has a lower pitch and is louder than Q.
 D P has a lower pitch and is quieter than Q.
- 26 A piece of magnetised steel is placed inside a coil of wire that has a large alternating current passing through it. The magnet is slowly moved out of the coil to position P.

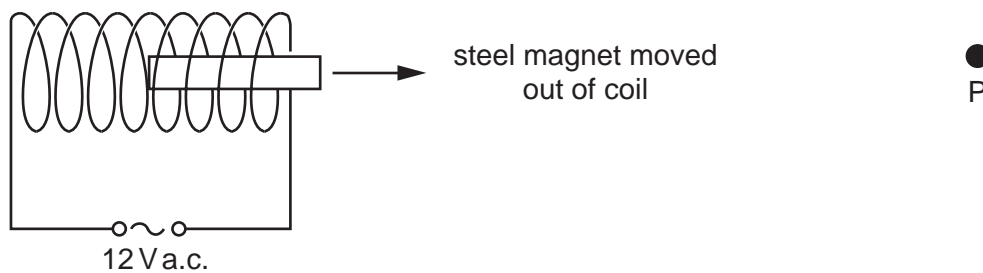

How has the steel changed when it reaches P?

- A It has become demagnetised.
 B There has been no change.
 C It has become a stronger magnet.
 D The poles have changed ends.

27 A permanent magnet is placed close to a bar of soft iron PQ.



What happens?

- A P becomes a north pole.
- B P becomes a south pole.
- C PQ does not become magnetised.
- D The poles of the magnet are reversed.

28 In which circuit does the ammeter read the total current through both resistors?

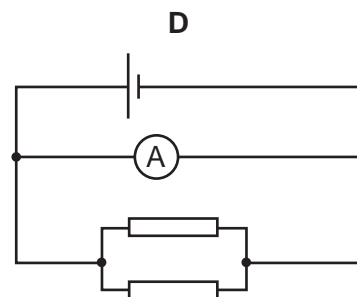
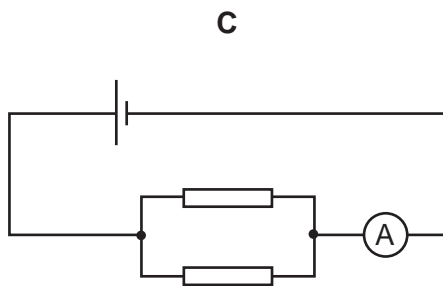
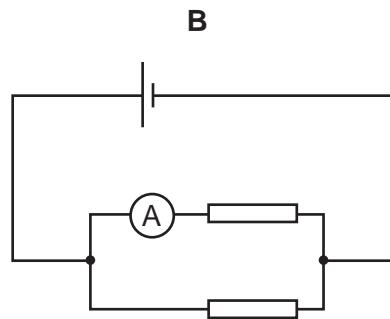
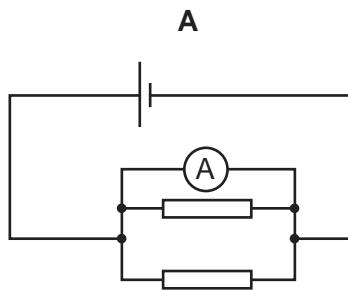

29 The table shows the voltage and current ratings for four light bulbs.

Which bulb has the greatest resistance when used normally?

	voltage / V	current / A
A	2	0.5
B	3	0.2
C	6	12
D	12	1.0

30 In the following circuits, the resistors have the same value and the cells are identical.

Which circuit has the smallest resistance?

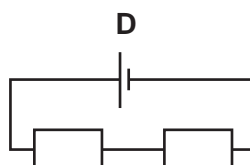
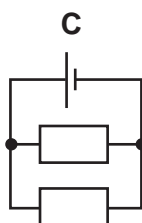
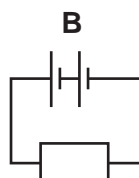
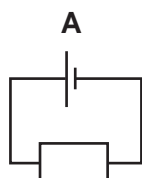

31 The diagram shows a circuit, with four possible positions to place a switch.

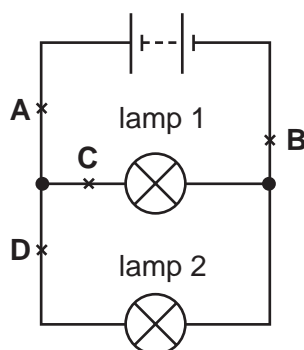

At which labelled point should a switch be placed so that lamp 1 remains on all the time and lamp 2 can be switched on and off?

- 32 The device X in this circuit is designed to cut off the electricity supply automatically if too much current flows.

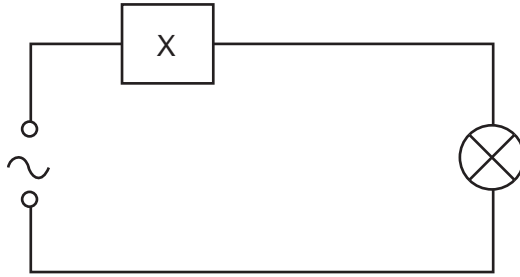

What is device X?

- A a fuse
 - B a relay
 - C a resistor
 - D an ammeter
- 33 A classroom has four lights, each fitted with a lamp marked 240 V, 100 W.
Which circuit is most suitable for the classroom?

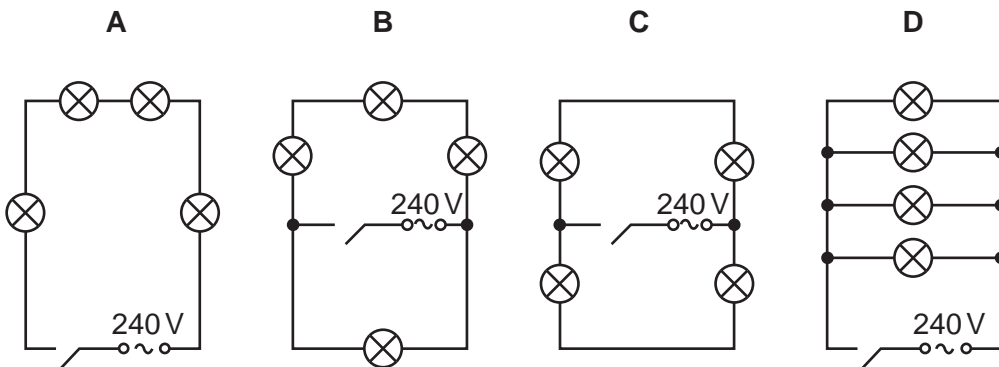

34 Which graph shows the output of a simple a.c. generator?

A

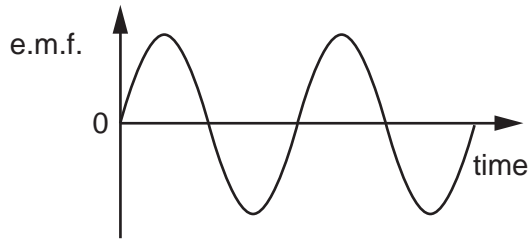

B

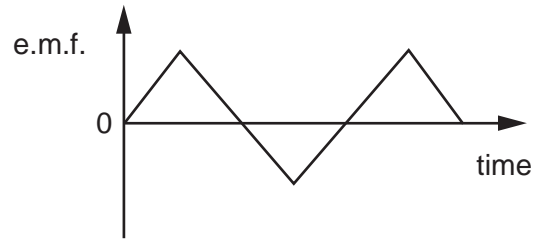

C

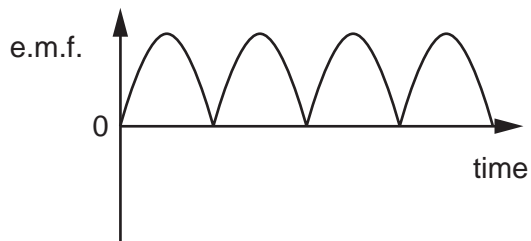

D

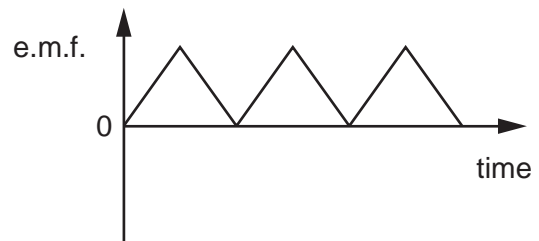

- 35 When the electric current in wire XY is in the direction shown, there is an upward force on the wire.

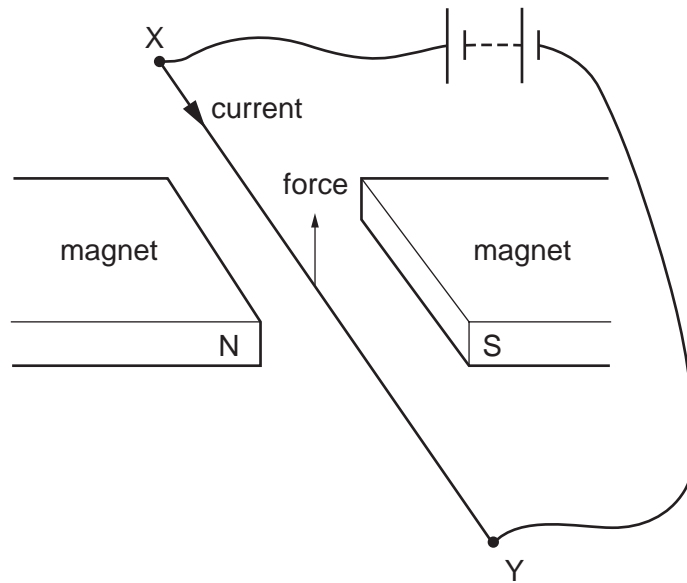

If the north and south poles of the magnet exchange positions, in which direction will the force on the wire act?

- A downwards
 - B upwards
 - C to the left
 - D to the right
- 36 Charged particles are emitted from the cathode of an oscilloscope.

What is the name and charge of these particles?

	name of particles	charge of particles
A	electrons	negative
B	electrons	positive
C	protons	negative
D	protons	positive

- 37 Diagram 1 shows a potential divider circuit containing two $100\ \Omega$ resistors.

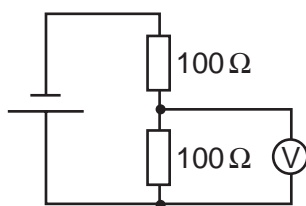

Diagram 1

One of the resistors is changed to $90\ \Omega$, as shown in diagram 2.

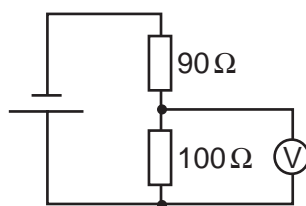
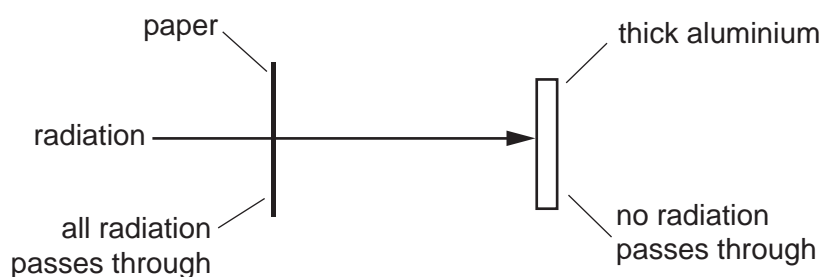

Diagram 2

How does the reading on the voltmeter change when this is done?

- A It becomes zero.
 - B It decreases a little.
 - C It increases a little.
 - D It stays the same.
- 38 A radioactive source emits radiation that can pass through a sheet of paper but not through thick aluminium.



What does this show about the radiation?

- A It is alpha-particles.
- B It is beta-particles.
- C It is gamma-rays.
- D It is a mixture of alpha-particles and gamma-rays.

39 A sample of a radioactive isotope is decaying.

Which atoms will decay first?

- A impossible to know, because radioactive decay is random
- B impossible to know, unless the age of the material is known
- C atoms near the centre, because they are surrounded by more atoms
- D atoms near the surface, because the radiation can escape more easily

40 Which line in the table gives the numbers of protons and neutrons in the nuclide ${}^7_3\text{Li}$?

	protons	neutrons
A	3	4
B	3	7
C	4	3
D	7	3

